

**LM2900, LM3900** For Specifications, See MC3301 Data.  
**LM2901** For Specifications, See LM139 Data.  
**LM2902** For Specifications, See LM124 Data.  
**LM2903** For Specifications, See LM193  
**LM2904** For Specifications, See LM158

### DUAL DIFFERENTIAL VOLTAGE COMPARATOR

... designed for use in level detection, low-level sensing, and memory applications.

- Two Separate Outputs
- Strobe Capability
- High Output Sink Current  
 2.8 mA Minimum (Each Comparator) for MC1514  
 1.6 mA Minimum (Each Comparator) for MC1414
- Differential Input Characteristics  
 Input Offset Voltage = 1.0 mV for MC1514  
 = 1.5 mV for MC1414  
 Offset Voltage Drift = 3.0  $\mu\text{V}/^\circ\text{C}$  for MC1514  
 = 5.0  $\mu\text{V}/^\circ\text{C}$  for MC1414
- Short Propagation Delay Time — 40 ns Typical
- Output Compatible with All Saturating Logic Forms  
 $V_O = +3.2\text{ V to } -0.5\text{ V Typical}$

#### MAXIMUM RATINGS ( $T_A = 25^\circ\text{C}$ unless otherwise noted.)

Rating	Symbol	Value	Unit
Power Supply Voltages	$V_{CC}$ $V_{EE}$	+ 14 - 7.0	Vdc
Differential Mode Input Voltage Range	$V_{IDR}$	$\pm 5.0$	Vdc
Common Mode Input Voltage Range	$V_{ICR}$	$\pm 7.0$	Vdc
Peak Load Current	$I_L$	10	mA
Power Dissipation (Package Limitation)	$P_D$		
Ceramic Dual In-Line Package		1000	mW
Derate above $T_A = 25^\circ\text{C}$		6.0	mW/ $^\circ\text{C}$
Plastic Dual In-Line Package		625	mW
Derate above $T_A = 25^\circ\text{C}$		5.0	mW/ $^\circ\text{C}$
Operating Temperature	$T_A$	- 55 to + 125 0 to + 75	$^\circ\text{C}$
Storage Temperature Range	$T_{stg}$	- 65 to + 150	$^\circ\text{C}$

#### CIRCUIT SCHEMATIC

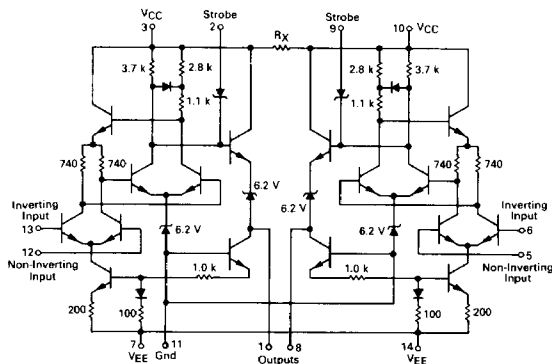

$R_X$  = Low Resistance Value, usually < 100  $\Omega$ , not specified.

**MC1414**  
**MC1514**

### DUAL DIFFERENTIAL COMPARATOR

(DUAL MC1710)

SILICON MONOLITHIC INTEGRATED CIRCUIT



L SUFFIX  
CERAMIC PACKAGE  
CASE 632

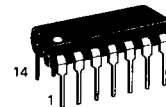

P SUFFIX  
PLASTIC PACKAGE  
CASE 646  
(MC1414 Only)

D SUFFIX  
PLASTIC PACKAGE  
CASE 751A  
(SO-14)  
(MC1414 Only)



#### PIN CONNECTIONS

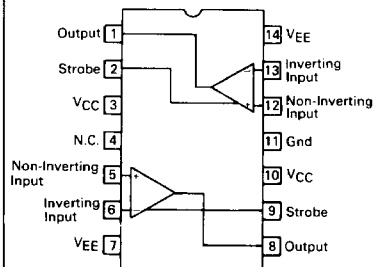

# MC1414, MC1514

**ELECTRICAL CHARACTERISTICS** ( $V_{CC} = +12$  Vdc,  $V_{EE} = -6.0$  Vdc,  $T_A = 25^\circ\text{C}$  unless otherwise noted.) (Each Comparator)

Characteristic	Symbol	MC1514			MC1414			Unit
		Min	Typ	Max	Min	Typ	Max	
Input Offset Voltage ( $V_O = 1.4$ Vdc, $T_A = 25^\circ\text{C}$ ) ( $V_O = 1.8$ Vdc, $T_A = T_{low}^*$ ) ( $V_O = 1.0$ Vdc, $T_A = T_{high}^*$ )	$V_{IO}$	—	1.0	2.0	—	1.5	5.0	mVdc
Temperature Coefficient of Input Offset Voltage	$\Delta V_{IO}/\Delta T$	—	3.0	—	—	5.0	—	$\mu\text{V}/^\circ\text{C}$
Input Offset Current ( $V_O = 1.4$ Vdc, $T_A = 25^\circ\text{C}$ ) ( $V_O = 1.8$ Vdc, $T_A = T_{low}$ ) ( $V_O = 1.0$ Vdc, $T_A = T_{high}$ )	$I_{IO}$	—	1.0	3.0	—	1.0	5.0	$\mu\text{Adc}$
Input Bias Current ( $V_O = 1.4$ Vdc, $T_A = 25^\circ\text{C}$ ) ( $V_O = 1.8$ Vdc, $T_A = T_{low}$ ) ( $V_O = 1.0$ Vdc, $T_A = T_{high}$ )	$I_{IB}$	—	12	20	—	15	25	$\mu\text{Adc}$
Open Loop Voltage Gain ( $T_A = 25^\circ\text{C}$ ) ( $T_A = T_{low}$ to $T_{high}$ )	$A_{Vol}$	1250 1000	1700 —	— —	1000 800	1500 —	— —	V/V
Output Resistance	$R_O$	—	200	—	—	200	—	Ohms
Differential Voltage Range	$V_{IDR}$	$\pm 5.0$	—	—	$\pm 5.0$	—	—	Vdc
High Level Output Voltage ( $V_{ID} \geq 5.0$ mV, $0 \leq I_O \leq 5.0$ mA)	$V_{OH}$	2.5	3.2	4.0	2.5	3.2	4.0	Vdc
Low Level Output Voltage ( $V_{ID} \geq -5.0$ mV, $I_{OS} = 2.8$ mA) ( $V_{ID} \geq -5.0$ mV, $I_{OS} = 1.6$ mA)	$V_{OL}$	-1.0 —	-0.5 —	0 —	— -1.0	— -0.5	— 0	Vdc
Output Sink Current ( $V_{ID} \geq -5.0$ mV, $V_{OL} \leq 0.4$ V, $T_A = T_{low}$ to $T_{high}$ )	$I_{OS}$	2.8	3.4	—	1.6	2.5	—	mAdc
Input Common Mode Voltage Range ( $V_{EE} = -7.0$ Vdc)	$V_{ICR}$	$\pm 5.0$	—	—	$\pm 5.0$	—	—	Vdc
Common-Mode Rejection Ratio ( $V_{EE} = -7.0$ Vdc, $R_S \leq 200$ $\Omega$ )	CMRR	80	100	—	70	100	—	dB
Strobe Low Level Current ( $V_{IL} = 0$ )	$I_{IL}$	—	—	2.5	—	—	2.5	mA
Strobe High Level Current ( $V_{IH} = 5.0$ Vdc)	$I_{IH}$	—	—	1.0	—	—	1.0	$\mu\text{A}$
Strobe Disable Voltage ( $V_{OL} \leq 0.4$ Vdc)	$V_{IL}$	—	—	0.4	—	—	0.4	Vdc
Strobe Enable Voltage ( $V_{OH} \geq 2.4$ Vdc)	$V_{IH}$	3.5	—	6.0	3.5	—	6.0	Vdc
Propagation Delay Time (Figure 1)	$t_{PLH}$ $t_{PHL}$	—	20 40	—	—	20 40	—	ns
Strobe Response Time (Figure 2)	$t_{so}$ $t_{sr}$	—	15 6.0	—	—	15 6.0	—	ns
Total Power Supply Current, Both Comparators ( $V_O \leq 0$ )	$I_{CC}$ $I_{EE}$	—	12.8 11	18 14	—	12.8 11	18 14	mAdc
Total Power Consumption, Both Comparators	$P_D$	—	230	300	—	230	300	mW

\* $T_{low} = -55^\circ\text{C}$  for MC1514,  $0^\circ\text{C}$  for MC1414  
 $T_{high} = +125^\circ\text{C}$  for MC1514,  $+75^\circ\text{C}$  for MC1414

FIGURE 1 — PROPAGATION DELAY TIME

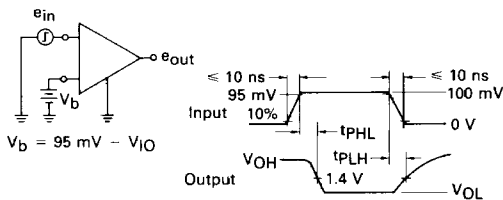
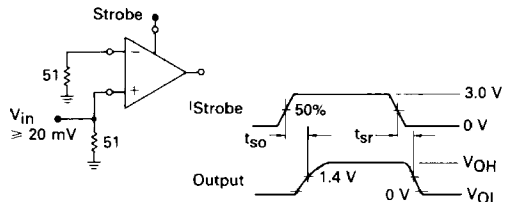

FIGURE 2 — STROBE RESPONSE TIME



# MC1414, MC1514

## TYPICAL CHARACTERISTICS (Each Comparator)

2

FIGURE 3 — VOLTAGE TRANSFER CHARACTERISTICS

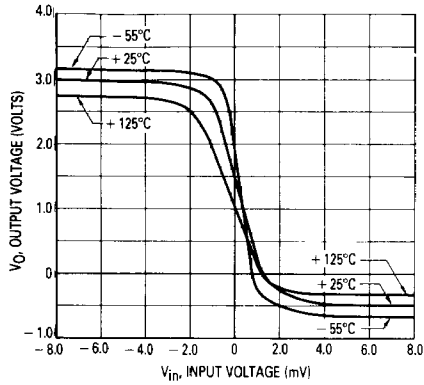

FIGURE 4 — INPUT OFFSET VOLTAGE versus TEMPERATURE

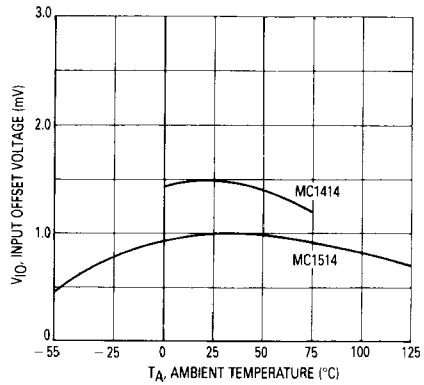

FIGURE 5 — INPUT OFFSET CURRENT versus TEMPERATURE

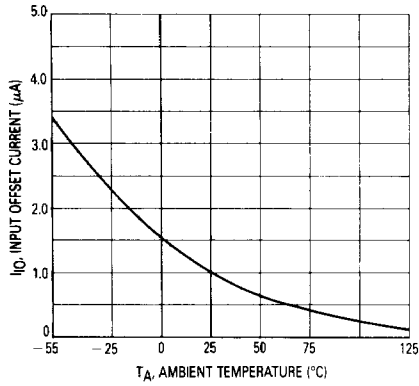

FIGURE 6 — INPUT BIAS CURRENT versus TEMPERATURE

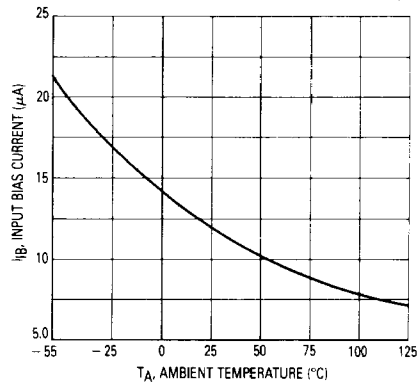

FIGURE 7 — GAIN VARIATION WITH POWER SUPPLY VOLTAGE

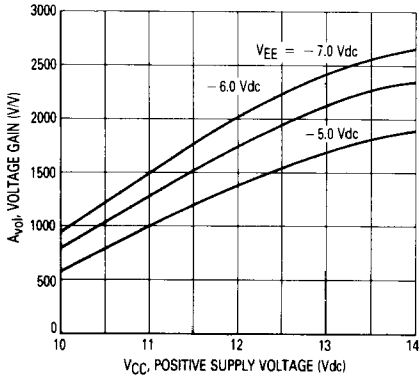

FIGURE 8 — VOLTAGE GAIN versus TEMPERATURE

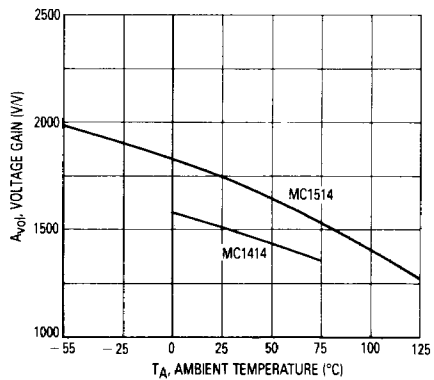

FIGURE 9 — RESPONSE TIME

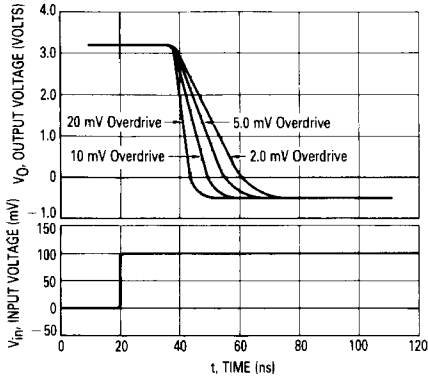

FIGURE 10 — POWER DISSIPATION versus TEMPERATURE

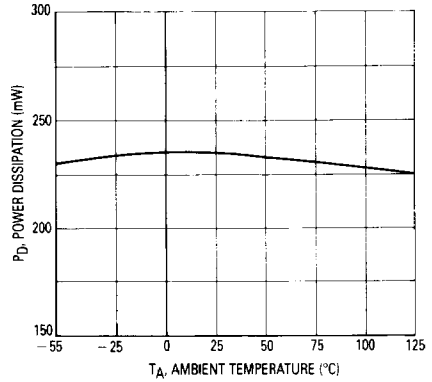

FIGURE 11 — RECOMMENDED SERIES RESISTANCE versus MRTL LOADS

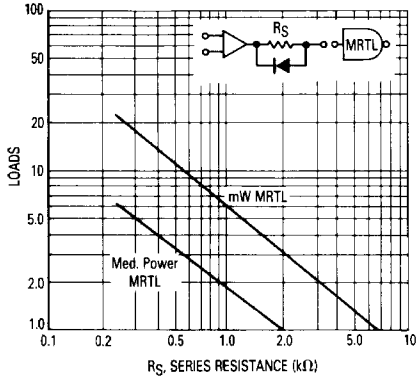

FIGURE 12 — SINK CURRENT versus TEMPERATURE

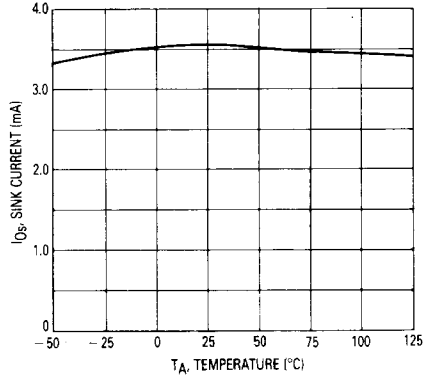
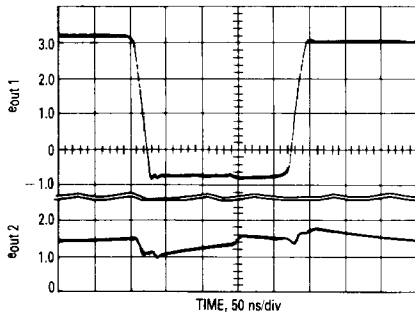

FIGURE 13 — CROSSTALK†



†Worst case condition shown — no load.

