

ROCKER SWITCHES

DS-850 SERIES

DS-850K-S-WD



DS-850K-F1-WD



DS-850K-RI-IO



DS-850C-S-00



DS-850S-F2-ON



DS-850S-F3-WD



DS-850シリーズ照光式波動 DS-850 SERIES ILLUMINATED

DS-850K-S-LR
(With LED)
LY
LG



DS-850K-F3-N1-K-TR
(With Neon)



U L 【File No. E43907】
CSA 【File No. LR26920】
VDE 【File No. 93570】

取付穴参考寸法 Mounting Hole Dimensions

パネル板厚 Panel Thickness	A寸法 A Size	B寸法 B Size
1mm	13 ^{+0.2} ₀ mm	19.1 ^{+0.2} ₀ mm
1.5mm		19.2 ^{+0.2} ₀ mm
2mm		19.4 ^{+0.2} ₀ mm
2.5mm		19.6 ^{+0.2} ₀ mm

品番 PARTS NO.	回路 CIRCUIT	スイッチ特性 SWITCHING FUNCTION	電流容量 RATING	絶縁抵抗 INSULATION RESISTANCE	絶縁耐圧 VOLTAGE BREAKDOWN	接触抵抗 CONTACT RESISTANCE
DS-850K-S- DS-850K-F1- DS-850K-RI- DS-850S-F2-	SPST (2P) DPST (4P)	ON-OFF	5A. 125V.AC 3A. 250V.AC 3/250~ T85	DC. 500V 100M 以上 (MIN)	AC. 2000V 分間 (Minute)	20m 以下 (MAX)
DS-850K-F3- DS-850S-F3-	SPST (2P) DPST (4P)		5A. 125V.AC 3A. 250V.AC 3/250~ T85			
DS-850A-S-00 DS-850A-F1-00	SPDT (3P)	ON-ON	5A. 125V.AC 3A. 250V.AC	DC. 500V 100M 以上 (MIN)	AC. 1500V 分間 (Minute)	
DS-850C-S-00 DS-850C-F1-00	SPDT (3P)	ON-OFF-ON	5A. 125V.AC 3A. 250V.AC			
DS-850K-S- (LED) DS-850K-F1- (LED)	SPST (2P)	ON-OFF	5A. 125V.AC 3A. 250V.AC			

DS-850シリーズ/SERIES

ご注文の際は下記の例に準じてご用命下さい。

ORDERING INFORMATION

DS-850 **S** - **F3** - **N1** - **K** - **T-R**
 1 2 3 4

*注記 NOTE

ネオン照光 NEON ILLUMINATED		
T-R	透明赤	Clear Red
T-G	透明緑	Clear Green
T-O	透明橙	Clear Orange

回路 CIRCUIT	1		2		3			4		
	スイッチ特性 SWITCHING FUNCTION		端子形状 SHAPE of TERMINAL		操作部 SHAPE of OPERATION PART			本体、ツマミ カラー KNOB & CASE COLOR		
								K	N	W
K	ON-OFF	SPST(2P)	S	ハンダ端子 Solder Terminal	OO	無印	without Symbol	○	○	△
			F1	タブ端子 #110 Tab Terminal	WD	点入り	with Symbol-Dot	○	△	×
			RI	ライトアングル端子 Right Angle Terminal	IO	IO表示	with Symbol-I-O	○	×	×
S	ON-OFF	DPST(4P)	F2	タブ端子 #187 t=0.5 Tab Terminal #187t=0.5	OO	無印	without Symbol	○	△	△
			F3	タブ端子 #187 t=0.8 Tab Terminal #187t=0.8	ON	ON-OFF表示	with Symbol-ON-OFF	○	△	△
A	ON-ON	SPDT(3P)	S	ハンダ端子 Solder Terminal	OO	無印	without Symbol	○	△	×
C	ON-OFF-ON	SPDT(3P)	F1	タブ端子 #110 Tab Terminal #110				○	△	×
LED照光スイッチ LED ILLUMINATED SWITCHES										
K	ON-OFF	SPST(2P)	S	ハンダ端子 Solder Terminal	LR	赤 Red	○	○	×	×
			F1	タブ端子 #110 Tab Terminal #110	LY	黄 Yellow				
ネオン照光スイッチ NEON ILLUMINATED SWITCHES										
K	ON-OFF	SPST(2P)	F3	タブ端子 #187 t=0.8 Tab Terminal #187t=0.8	N1	125V用 ネオン球付 with Neon 125V type	○	△	×	×
S	ON-OFF	DPST(4P)			N2	250V用 ネオン球付 with Neon 250V type	○	△	×	×

注記 (NOTE)

○=標準色 Standard Color

△=受注生産 Order-received production

本体・ツマミ・カラー KNOB & CASE COLOR		
K	黒	Black
N	グレー	Gray
W	白	White

* 端子形状F3タイプはVDE規格上では半田端子区分になります。

* Terminal Shape 'F3 Tab' belongs to the classification of 'solder terminal' on the VDE standards.

DS-850シリーズ / SERIES

外形図 / Dimensions

DS-850K-S-□

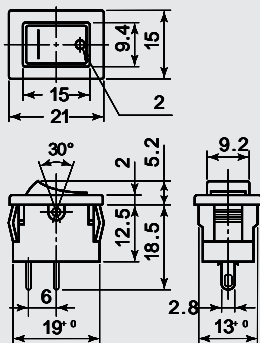

DS-850K-S-WD



DS-850K-F1-□

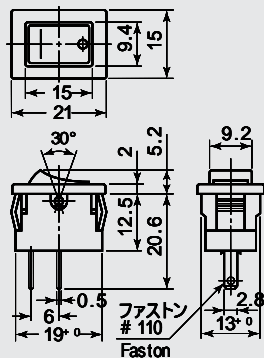

DS-850K-F1-WD

DS-850K-RI-□

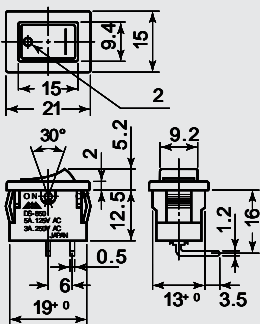

DS-850K-RI-WD

DS-850S-F2-□

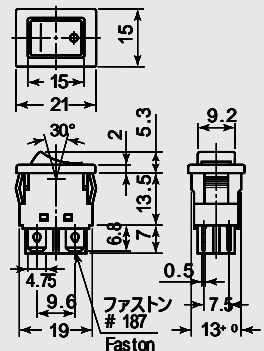

DS-850S-F2-WD

DS-850C-S-□

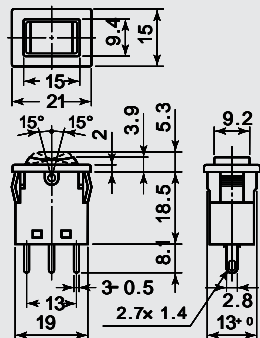

DS-850C-S-00

DS-850S-F3-□

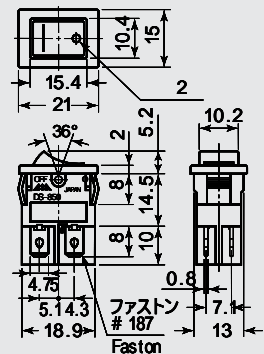

DS-850S-F3-WD

DS-850シリーズ/SERIES LED照光式/LED ILLUMINATED SWITCHES

DS-850K-S-LR
(with LED) **LY**
LG

UL Listed
CSA

(Available with "UL Mark")

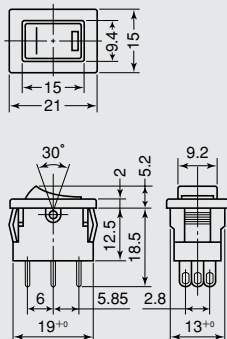

DS-850K-F1-LR
(with LED) **LY**
LG

UL Listed
CSA

(Available with "UL Mark")

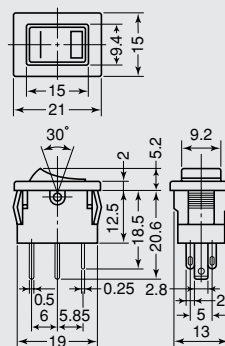

LED仕様 Specifications

絶対最大定格 (周囲温度 $T_a=25^\circ\text{C}$)

Absolute maximum ratings

$T_a=25^\circ\text{C}$

Color	P (mW)	IF (mA)	IFM (mA)	VR (V)	Top. ($^\circ\text{C}$)	Tatg ($^\circ\text{C}$)
Red	80	40	300	4	-30~ +85	-30~ +100
Yellow	100		100			
Green	100		100			

動作特性 (順電流 $I_F=20\text{mA}$, 周囲温度 $T_a=25^\circ\text{C}$)

Electro-optical characteristics

$I_F=20\text{mA}$, $T_a=25^\circ\text{C}$

Color	VF (Typ.) (V)	IR (Max) (μA)	Cd (mcd)		λP (Typ.) (nm)	$\Delta\lambda$ (Typ.) (nm)
			Min.	Typ.		
Red	1.7	100	12	24	660	30
Yellow	2.1	100	10	15	570	30
Green	2.1	100	2	4	555	30

DS-850シリーズ/SERIES 照光式(ネオン)/NEON ILLUMINATED SWITCHES

DS-850K-F3-N1-K-TR

(with Neon)



CIRCUIT

DS-850K-F3-N1 or N2

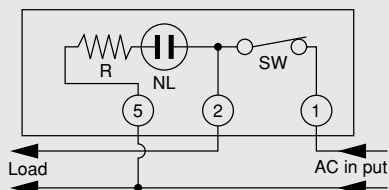

DS-850S-F3-N1 or N2

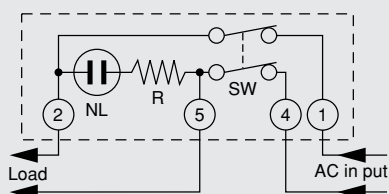

ランプ回路表示
Lamp Circuit View

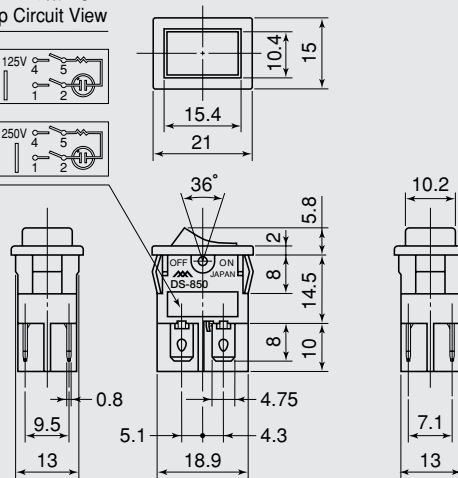
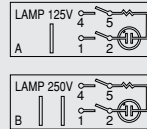

DS-850S-F3

