

Multi-layer ceramic chip capacitors

MCH15 (1005 (0402) size, chip capacitor)

●Features

- 1) Small size (1.0 x 0.5 x 0.5 mm) makes it perfect for lightweight portable devices.
- 2) Comes packed either in tape to enable automatic mounting or in bulk cases.
- 3) Precise uniformity of shape and dimensions facilitates highly efficient automatic mounting.
- 4) Barrier layer and end terminations to improve solderability.

●External dimensions (Units : mm)

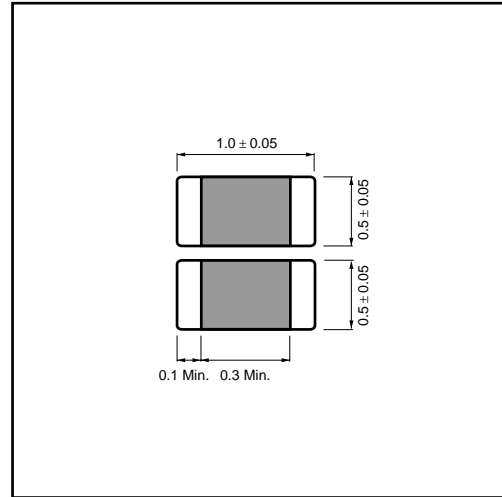

●Structure

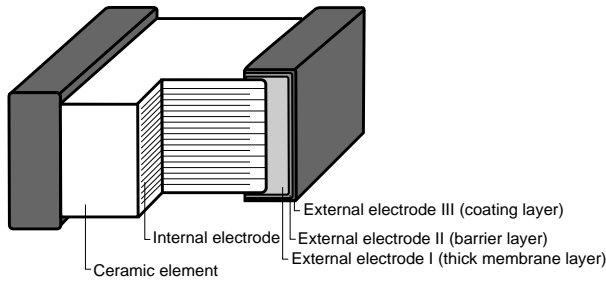

●Product designation

| Code | Product thickness | Packaging specifications | Reel | Basic ordering unit (pcs.) |
|------|-------------------|-------------------------------------|----------------|----------------------------|
| K | 0.5mm | Paper tape (width 8 mm, pitch 2 mm) | φ180mm (7in.) | 10,000 |
| L | 0.5mm | Paper tape (width 8 mm, pitch 2 mm) | φ330mm (13in.) | 50,000 |
| C | 0.5mm | Bulk case | - | 50,000 |

Reel (φ180, φ330mm) : compatible with EIAJ ETX-7001
 Bulk case: according to EIAJ ET-7201A

Packaging style

Part No.



| Rated voltage | |
|---------------|---------|
| Code | Voltage |
| 2 | 25V |
| 3 | 16V |
| 5 | 50V |

| Capacitance-temperature characteristics | | | | Nominal capacitance | Capacitance tolerance | |
|---|----------|----------------------------|-------------------------------------|--------------------------------------|-----------------------|----------------------|
| Code | EIA code | Operating temperature (°C) | Temp. coefficient or percent change | | Code | tolerance |
| A | C0G | -55 to + 125 | 0 ± 30ppm / °C | 3-digit designation according to IEC | C | ± 0.25pF (0.5 - 5pF) |
| C | X7R | -55 to + 125 | ± 15% | | D | ± 0.5pF (5.1 - 10pF) |
| F | Y5V | -30 to + 85 | + 22%, -82% | | J | ± 5% (11pF or more) |
| | | | | | K | ± 10% |
| | | | | | Z | + 80%, -20% |

*The design and specifications are subject to change without prior notice. Before ordering or using, please check the latest technical specification.

Ceramic capacitors

●Capacitance range

For thermal compensation

| Part number | | MCH15 | | |
|------------------|--------------------------------|--------------------------|--------------------------|--------------------------|
| Capacitance (pF) | Temperature characteristics | A (C0G) | | |
| | Rated voltage (V) Tolerance | 50V | | |
| 0.5 | C (± 0.25pF) | <input type="checkbox"/> | | |
| 0.75 | | <input type="checkbox"/> | | |
| 1 | | <input type="checkbox"/> | | |
| 1.1 | | <input type="checkbox"/> | | |
| 1.2 | | <input type="checkbox"/> | | |
| 1.3 | | <input type="checkbox"/> | | |
| 1.5 | | <input type="checkbox"/> | | |
| 1.6 | | <input type="checkbox"/> | | |
| 1.8 | | <input type="checkbox"/> | | |
| 2 | | <input type="checkbox"/> | | |
| 2.2 | | <input type="checkbox"/> | | |
| 2.4 | | <input type="checkbox"/> | | |
| 2.7 | | <input type="checkbox"/> | | |
| 3 | | <input type="checkbox"/> | | |
| 3.3 | | <input type="checkbox"/> | | |
| 3.6 | | <input type="checkbox"/> | | |
| 3.9 | | <input type="checkbox"/> | | |
| 4 | | <input type="checkbox"/> | | |
| 4.3 | | <input type="checkbox"/> | | |
| 4.7 | | <input type="checkbox"/> | | |
| 5 | | <input type="checkbox"/> | | |
| 5.1 | | D (± 0.5pF) | <input type="checkbox"/> | |
| 5.6 | | | <input type="checkbox"/> | |
| 6 | | | <input type="checkbox"/> | |
| 6.2 | | | <input type="checkbox"/> | |
| 6.8 | | | <input type="checkbox"/> | |
| 7 | | | <input type="checkbox"/> | |
| 7.5 | | | <input type="checkbox"/> | |
| 8 | | | <input type="checkbox"/> | |
| 8.2 | | | <input type="checkbox"/> | |
| 9 | | | <input type="checkbox"/> | |
| 9.1 | | | <input type="checkbox"/> | |
| 10 | | | <input type="checkbox"/> | |
| 11 | | | J (± 5%) | <input type="checkbox"/> |
| 12 | | | | <input type="checkbox"/> |
| 13 | | | | <input type="checkbox"/> |
| 15 | | <input type="checkbox"/> | | |
| 16 | | <input type="checkbox"/> | | |
| 18 | | <input type="checkbox"/> | | |
| 20 | | <input type="checkbox"/> | | |
| 22 | | <input type="checkbox"/> | | |
| 24 | | <input type="checkbox"/> | | |
| 27 | | <input type="checkbox"/> | | |
| 30 | <input type="checkbox"/> | | | |
| 33 | <input type="checkbox"/> | | | |
| 36 | <input type="checkbox"/> | | | |
| 39 | <input type="checkbox"/> | | | |
| 43 | <input type="checkbox"/> | | | |

| Part number | | MCH15 |
|------------------|--------------------------------|--------------------------|
| Capacitance (pF) | Temperature characteristics | A (C0G) |
| | Rated voltage (V) Tolerance | 50V |
| 47 | J (± 5%) | <input type="checkbox"/> |
| 51 | | <input type="checkbox"/> |
| 56 | | <input type="checkbox"/> |
| 62 | | <input type="checkbox"/> |
| 68 | | <input type="checkbox"/> |
| 75 | | <input type="checkbox"/> |
| 82 | | <input type="checkbox"/> |
| 91 | | <input type="checkbox"/> |
| 100 | | <input type="checkbox"/> |
| 110 | | <input type="checkbox"/> |
| 120 | | <input type="checkbox"/> |
| 130 | | <input type="checkbox"/> |
| 150 | | <input type="checkbox"/> |
| 160 | | <input type="checkbox"/> |
| 180 | | <input type="checkbox"/> |
| 200 | | <input type="checkbox"/> |
| 220 | | <input type="checkbox"/> |
| 240 | | <input type="checkbox"/> |
| 270 | | <input type="checkbox"/> |
| 300 | | <input type="checkbox"/> |
| 330 | | <input type="checkbox"/> |
| 360 | | <input type="checkbox"/> |
| 390 | | <input type="checkbox"/> |
| 430 | | <input type="checkbox"/> |
| 470 | | <input type="checkbox"/> |
| 510 | | <input type="checkbox"/> |
| 560 | | <input type="checkbox"/> |

Product thickness (mm) 0.5 ± 0.05

*The design and specifications are subject to change without prior notice. Before ordering or using, please check the latest technical specification.

Ceramic capacitors

●Capacitance range

High dielectric constant

| Part number | | MCH15 | | | | | |
|------------------|-----------------------------|--------------------------|--------------------------|--------------------------|--------------------------|--------------------------|--------------------------|
| Capacitance (pF) | Temperature characteristics | C (X7R) | | | F (Y5V) | | |
| | Rated voltage (V) | 50V | 25V | 16V | 50V | 25V | 16V |
| | Tolerance | K (±10%) | | | Z (+80, -20%) | | |
| 220 | | <input type="checkbox"/> | | | | | |
| 270 | | <input type="checkbox"/> | | | | | |
| 330 | | <input type="checkbox"/> | | | | | |
| 390 | | <input type="checkbox"/> | | | | | |
| 470 | | <input type="checkbox"/> | | | | | |
| 560 | | <input type="checkbox"/> | | | | | |
| 680 | | <input type="checkbox"/> | | | | | |
| 820 | | <input type="checkbox"/> | | | | | |
| 1,000 | | <input type="checkbox"/> | | | <input type="checkbox"/> | | |
| 1,200 | | <input type="checkbox"/> | | | | | |
| 1,500 | | <input type="checkbox"/> | | | | | |
| 1,800 | | <input type="checkbox"/> | | | | | |
| 2,200 | | <input type="checkbox"/> | | | <input type="checkbox"/> | | |
| 2,700 | | <input type="checkbox"/> | | | | | |
| 3,300 | | <input type="checkbox"/> | | | | | |
| 3,900 | | <input type="checkbox"/> | | | | | |
| 4,700 | | | <input type="checkbox"/> | | <input type="checkbox"/> | | |
| 5,600 | | | <input type="checkbox"/> | | | | |
| 6,800 | | | <input type="checkbox"/> | | | | |
| 8,200 | | | | <input type="checkbox"/> | | | |
| 10,000 (0.01μF) | | | | <input type="checkbox"/> | <input type="checkbox"/> | | |
| 12,000 | | | | | <input type="checkbox"/> | | |
| 15,000 | | | | | <input type="checkbox"/> | | |
| 18,000 | | | | | | | |
| 22,000 | | | | | | <input type="checkbox"/> | |
| 27,000 | | | | | | <input type="checkbox"/> | |
| 33,000 | | | | | | | |
| 39,000 | | | | | | | <input type="checkbox"/> |
| 47,000 | | | | | | | <input type="checkbox"/> |
| 56,000 | | | | | | | <input type="checkbox"/> |
| 68,000 | | | | | | | <input type="checkbox"/> |
| 82,000 | | | | | | | <input type="checkbox"/> |
| 100,000 (0.1μF) | | | | | | | <input type="checkbox"/> |
| 120,000 | | | | | | | |
| 150,000 | | | | | | | |
| 180,000 | | | | | | | |
| 220,000 | | | | | | | |
| 270,000 | | | | | | | |
| 330,000 | | | | | | | |
| 390,000 | | | | | | | |
| 470,000 | | | | | | | |
| 560,000 | | | | | | | |



Product thickness (mm) 0.5 ± 0.05

*The design and specifications are subject to change without prior notice. Before ordering or using, please check the latest technical specification.

Ceramic capacitors

● Characteristics

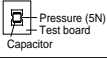
Class 1 (For thermal compensation)



| Temperature characteristics | | A (COG) | Test methods/conditions (based on JIS C 5102) |
|------------------------------------|----------------------------|--|--|
| Item | | | |
| Operating temperature | | -55°C ~ 125°C | |
| Nominal capacitance (C) | | Must be within the specified tolerance range. | Based on paragraph 7.8 and paragraph 9 Measured at room temperature and standard humidity, 1000pF or less Measurement frequency : 1 ± 0.1MHz Measurement voltage : 1 ± 0.1Vrms. |
| Dissipation factor (tanδ) | | 100/(400+20C)% or less: Less than 30 pF 0.1% or less: 30 pF or larger | Over 1000pF Measurement frequency : 1 ± 0.1kHz Measurement voltage : 1 ± 0.1Vrms. |
| Insulation resistance (IR) | | 10,000 MΩ or 500 MΩ · μF, whichever is smaller | Based on paragraph 7.6 Measurement is made after rated voltage is applied for 60 ± 5s. |
| Withstanding voltage | | The insulation must not be damaged. | Based on paragraph 7.1 Apply 300% of the rated voltage for 1 to 5s then measure. |
| Temperature characteristics | | Within 0 ± 30ppm/°C | The temperature coefficients in table 12, paragraph 7.12 are calculated at 20°C and high temperature. |
| Terminal adherence | | No detachment or signs of detachment. | Based on paragraph 8.11, 2. Apply 5N (0.51 kg · f) for 10 ± 1s in the direction indicated by the arrow.  |
| Resistance to vibration | Appearance | There must be no mechanical damage. | Chip is mounted to a board in the manner shown on the right, subjected to vibration (type A in paragraph 8.2), and measured 24 ± 2 hrs. later.  |
| | Rate of capacitance change | Must be within initial tolerance. | |
| | tanδ | Must satisfy initial specified value. | |
| Solderability | | At least 3/4 of the surface of the two terminals must be covered with new solder. | Based on paragraph 8.13 Soldering temperature: 235 ± 5°C Soldering time : 2 ± 0.5s |
| Resistance to soldering heat | Appearance | There must be no mechanical damage. | Based on paragraph 8.14. Soldering temperature: 260 ± 5°C Soldering time : 5 ± 0.5s Preheating : 150 ± 10°C for 1 to 2 min. |
| | Rate of capacitance change | ± 2.5% or ± 0.25 pF, whichever is larger. | |
| | tanδ | Must satisfy initial specified value. | |
| | Insulation resistance | 10,000 MΩ or 500 MΩ · μF, whichever is smaller | |
| | Withstanding voltage | The insulation must not be damaged. | |
| Temperature cycling | Appearance | There must be no mechanical damage. | Based on paragraph 9.3 Number of cycles: 10 Capacitance measured after 24 ± 2 hrs. |
| | Rate of capacitance change | ± 2.5% or ± 0.25 pF, whichever is larger. | |
| | tanδ | Must satisfy initial specified value. | |
| | Insulation resistance | 10,000 MΩ or 500 MΩ · μF, whichever is smaller | |
| Humidity load test | Appearance | There must be no mechanical damage. | Based on paragraph 9.9 Test temperature: 40 ± 2°C Relative humidity: 90% to 95% Applied voltage : rated voltage Test time : 500 to 524 hrs. Capacitance measured after 24 ± 2 hrs. |
| | Rate of capacitance change | ± 7.5% or ± 0.75 pF, whichever is larger. | |
| | tanδ | 0.5% or less | |
| | Insulation resistance | 500 MΩ or 25 MΩ · μF, whichever is smaller | |
| High- temperature load test | Appearance | There must be no mechanical damage. | Based on paragraph 9.10 Test temperature : Max. operating temp. Applied voltage : rated voltage x 200% Test time : 1,000 to 1,048 hrs. Capacitance measured after 24 ± 2 hrs. |
| | Rate of capacitance change | ± 3.0% or ± 0.3 pF, whichever is larger. | |
| | tanδ | 0.3% or less | |
| | Insulation resistance | 1,000 MΩ or 50 MΩ · μF, whichever is smaller | |

*The design and specifications are subject to change without prior notice. Before ordering or using, please check the latest technical specification.

Ceramic capacitors

● Characteristics

Class 2 (High dielectric constant)

| Temperature characteristics | | C (X7R) | | F (Y5V) | Test methods/conditions (based on JIS C 5102) |
|------------------------------|----------------------------|---|--|---|--|
| | | Item | | | |
| Operating temperature | | -55°C ~ +125°C | | -30°C ~ +85°C | — |
| Nominal capacitance (C) | | Must be within the specified tolerance range. | | | Based on paragraph 7.8 Measured at room temperature and standard humidity, Measurement frequency: 1 ± 0.1 kHz Measurement voltage : 1.0 ± 0.2 Vrms. |
| Tanδ | | 2.5% or less (when rated voltage is 16V: 3.5% or less) | | 5.0% or less (when rated voltage is 16V: 7.5% or less) | |
| Insulation resistance (IR) | | 10,000 MΩ or 500 MΩ · μF, whichever is smaller | | | Based on paragraph 7.6 Measurement is made after rated voltage is applied for 60 ± 5s. |
| Withstanding voltage | | The insulation must not be damaged. | | | Based on paragraph 7.1 Apply 250% of the rated voltage for 1 to 5s then measure. |
| Temperature characteristics | | Within ± 15% | | + 22, + 82% | The temperature coefficients in paragraph 7.12, table 8, condition B, are based on measurements carried out at 20°C, with no voltage applied. |
| Terminal adherence | | No detachment or signs of detachment | | | Based on paragraph 8.11.2. Apply 5N (0.51 kg · f) for 10 ± 1s in the direction indicated by the arrow.  |
| Resistance to vibration | Appearance | There must be no mechanical damage. | | | Chip is mounted to a board in the manner shown on the right, subjected to vibration (type A in paragraph 8.2), and measured 48 ± 4 hrs. later.  |
| | Rate of capacitance change | Must be within initial tolerance. | | | |
| | Dissipation factor | Must satisfy initial specified value. | | | |
| Solderability | | At least 3/4 of the surface of the two terminals must be covered with new solder. | | | Based on paragraph 8.13 Soldering temperature: 235 ± 5°C Soldering time : 2 ± 0.5s |
| Resistance to soldering heat | Appearance | There must be no mechanical damage. | | | Based on paragraph 8.14. Soldering temperature: 260 ± 5°C Soldering time : 5 ± 0.5s Preheating : 150 ± 10°C for 1 to 2 min. |
| | Rate of capacitance change | Within ± 5.0% | | Within ± 20.0% | |
| | Dissipation factor | Must satisfy initial specified value. | | | |
| | Insulation resistance | 10,000 MΩ or 500 MΩ · μF, whichever is smaller | | | |
| | Withstanding voltage | The insulation must not be damaged. | | | |
| Temperature cycling | Appearance | There must be no mechanical damage. | | | Based on paragraph 9.3 Number of cycles: 10 Capacitance measured after 48 ± 4 hrs. |
| | Rate of capacitance change | Within ± 7.5% | | Within ± 20.0% | |
| | Dissipation factor | Must satisfy initial specified value. | | | |
| | Insulation resistance | 10,000 MΩ or 500 MΩ · μF, whichever is smaller | | | |
| Humidity load test | Appearance | There must be no mechanical damage. | | | Based on paragraph 9.9 Test temperature: 40 ± 2°C Relative humidity: 90% to 95% Applied voltage : rated voltage Test time : 500 to 524 hrs. Capacitance measured after 48 ± 4 hrs. |
| | Rate of capacitance change | ± 12.5% or less | | Within ± 30.0% | |
| | Dissipation factor | 5.0% or less | | 7.5% or less (when rated voltage is 16V: 10.0%) | |
| | Insulation resistance | 500 MΩ or 25 MΩ · μF, whichever is smaller | | | |
| High-temperature load test | Appearance | There must be no mechanical damage. | | | Based on paragraph 9.10 Test temperature: Max. operating temp. Applied voltage : rated voltage x 200% Test time : 1,000 to 1,048 hrs. Capacitance measured after 48 ± 4 hrs. |
| | Rate of capacitance change | Within ± 10.0% | | Within ± 30.0% | |
| | Dissipation factor | 5.0% or less | | 7.5% or less (when rated voltage is 16V: 10.0%) | |
| | Insulation resistance | 1,000MΩ or 50 MΩ · μF, whichever is smaller | | | |

*The design and specifications are subject to change without prior notice. Before ordering or using, please check the latest technical specification.

Ceramic capacitors

●Packaging specifications

(Unit: mm)

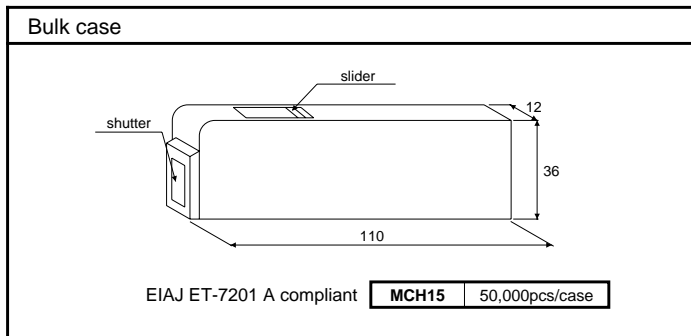
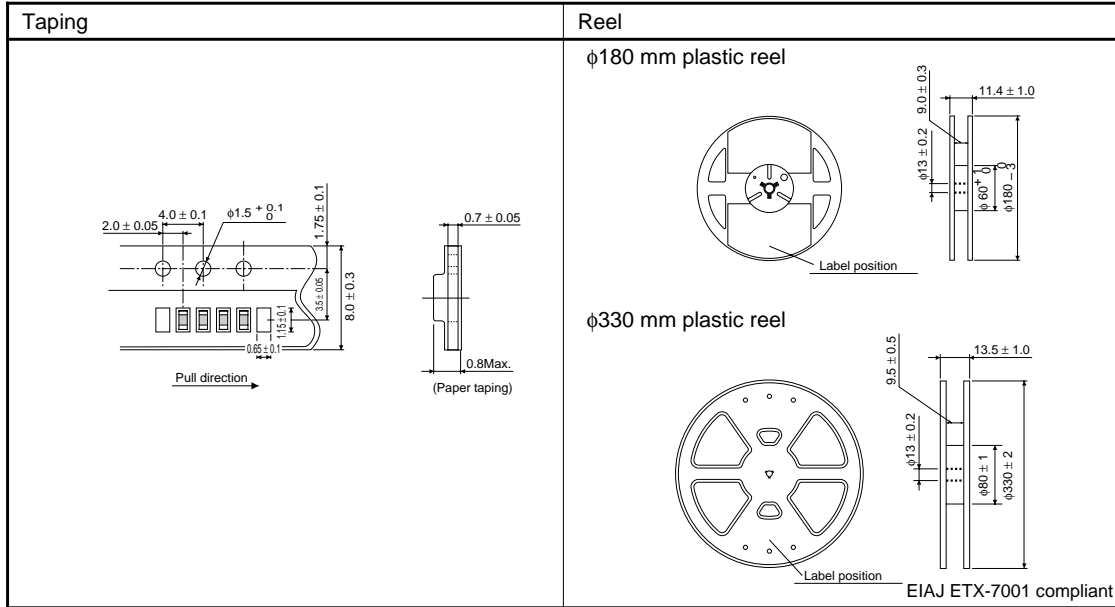

*The design and specifications are subject to change without prior notice. Before ordering or using, please check the latest technical specification.

Ceramic capacitors

● Electrical characteristics

■ A (C0G) Characteristics

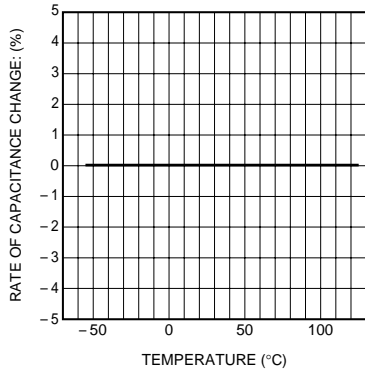

Fig.1 Capacitance-temperature characteristics

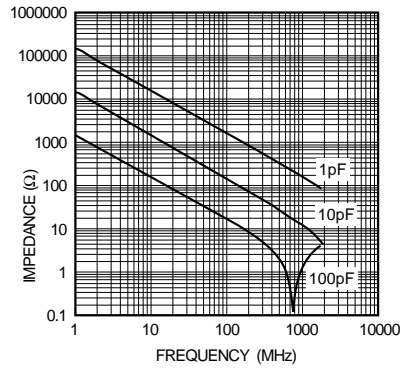

Fig.2 Impedance-frequency characteristics

■ C (X7R) Characteristics

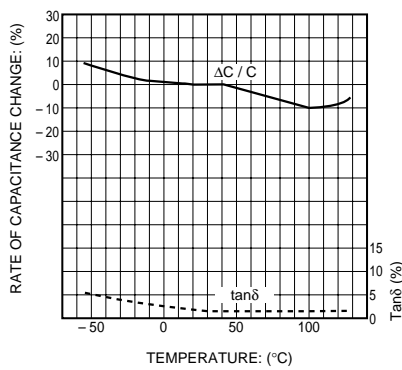

Fig.3 Capacitance-temperature characteristics

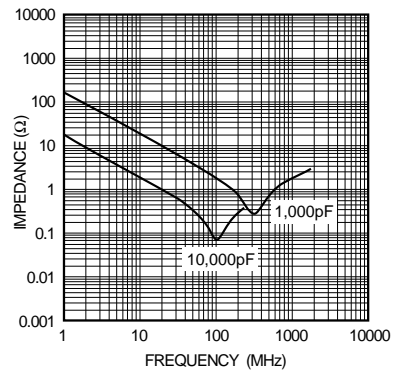

Fig.4 Impedance-frequency characteristics

■ F (Y5V) Characteristics

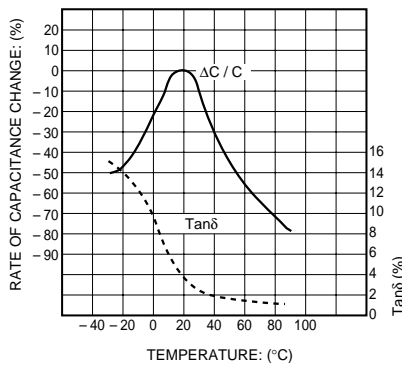

Fig.5 Capacitance-temperature characteristics

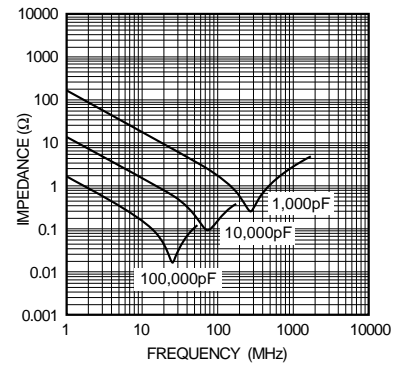

Fig.6 Impedance-frequency characteristics

*The design and specifications are subject to change without prior notice. Before ordering or using, please check the latest technical specification.

Ceramic capacitors

Temperature cycling test

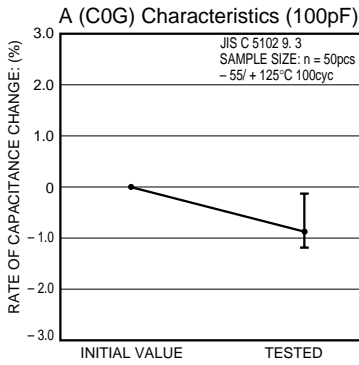

Fig.7 Rate of capacitance change

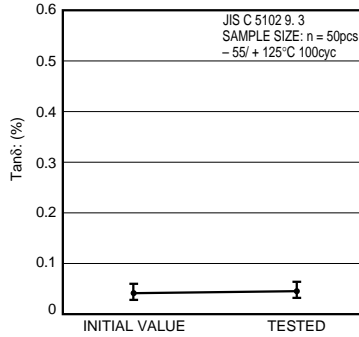

Fig.8 Tanδ

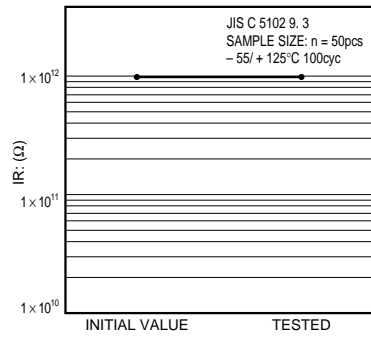

Fig.9 Insulation resistance

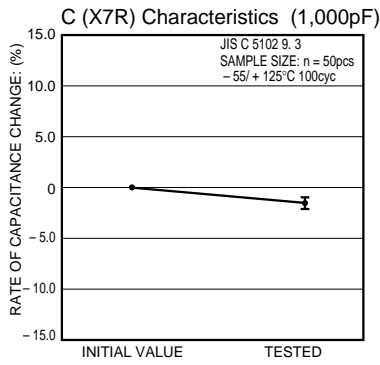

Fig.10 Rate of capacitance change

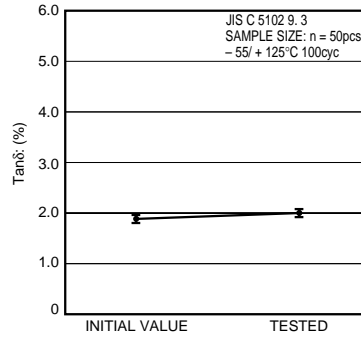

Fig.11 Tanδ

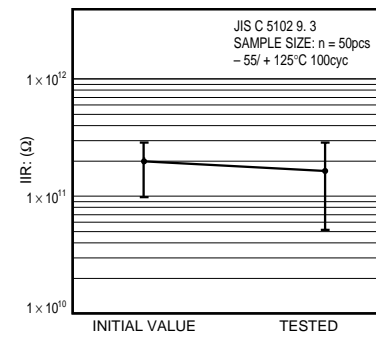

Fig.12 Insulation resistance

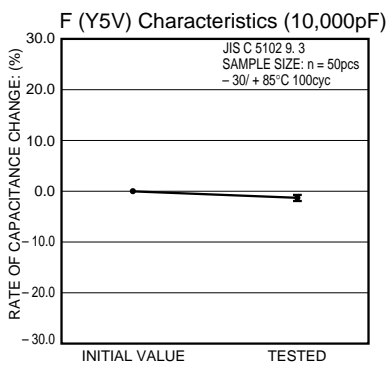

Fig.13 Rate of capacitance change

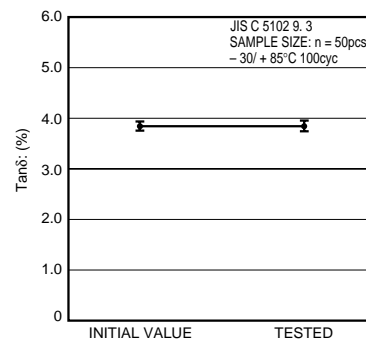

Fig.14 Tanδ

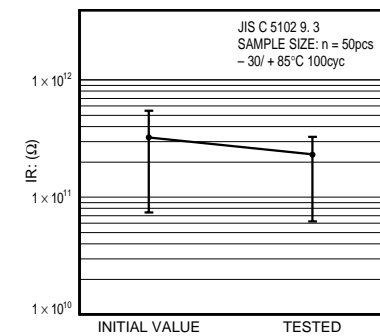

Fig.15 Insulation resistance

*The design and specifications are subject to change without prior notice. Before ordering or using, please check the latest technical specification.

Ceramic capacitors

High-temperature load test

A (C0G) Characteristics (100pF)

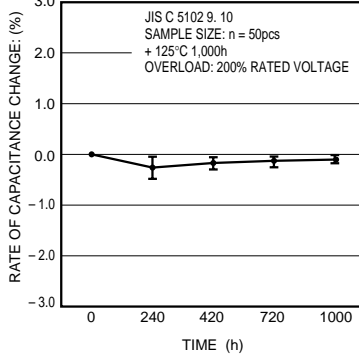

Fig.16 Rate of capacitance change

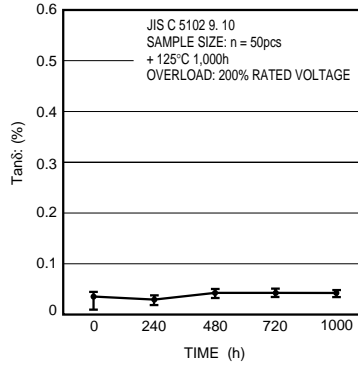

Fig.17 Tanδ

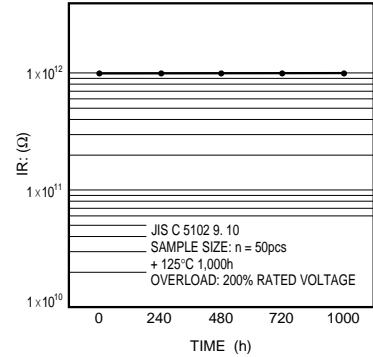

Fig.18 Insulation resistance

C (X7R) Characteristics (1,000pF)

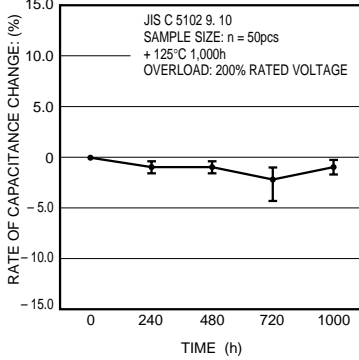

Fig.19 Rate of capacitance change

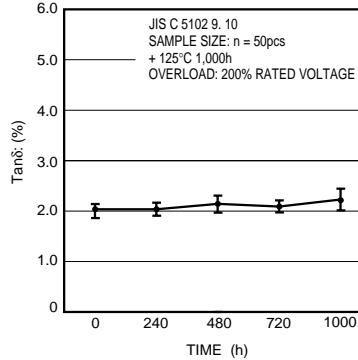

Fig.20 Tanδ

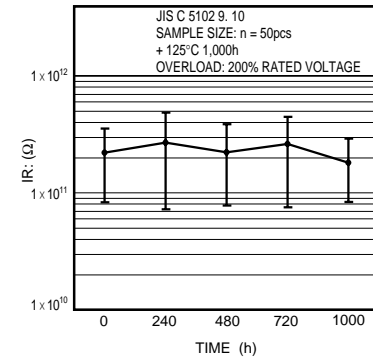

Fig.21 Insulation resistance

F (Y5V) Characteristics (10,000pF)

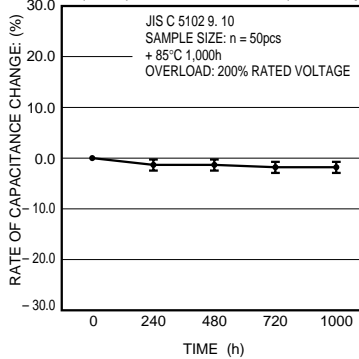

Fig.22 Rate of capacitance change

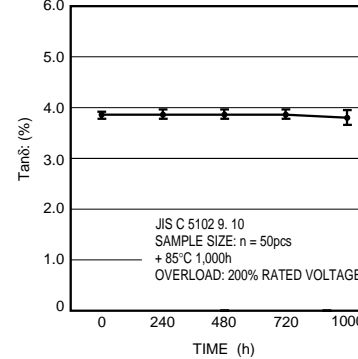

Fig.23 Tanδ

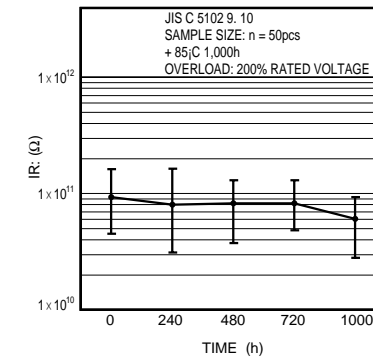

Fig.24 Insulation resistance

*The design and specifications are subject to change without prior notice. Before ordering or using, please check the latest technical specification.

Ceramic capacitors

■ Humidity load test

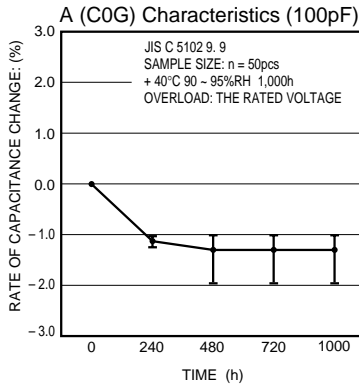

Fig.25 Rate of capacitance change

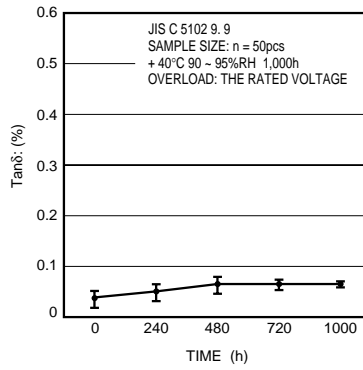

Fig.26 Tanδ

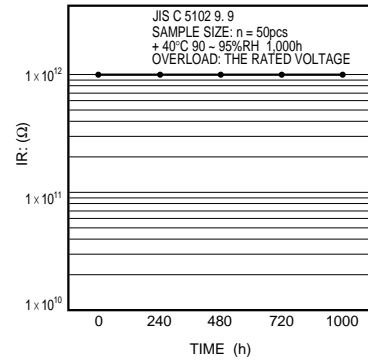

Fig.27 Insulation resistance

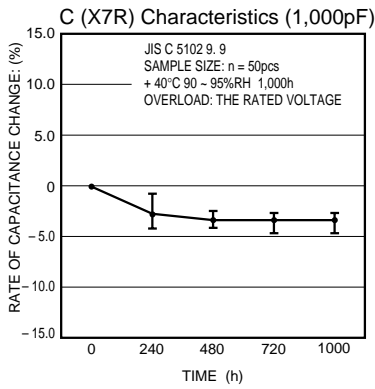

Fig.28 Rate of capacitance change

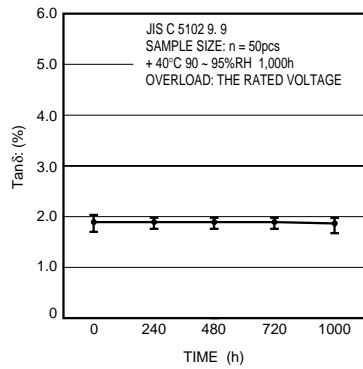

Fig.29 Tanδ

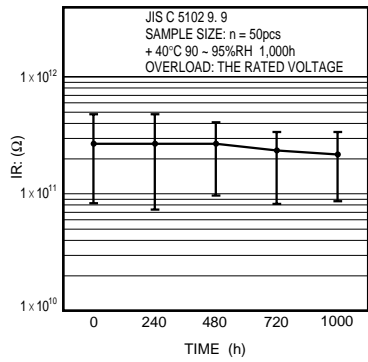

Fig.30 Insulation resistance

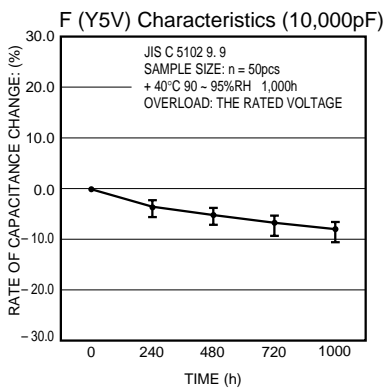

Fig.31 Rate of capacitance change

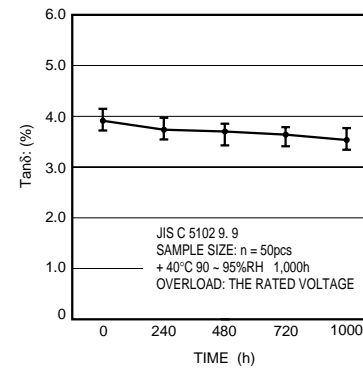

Fig.32 Tanδ

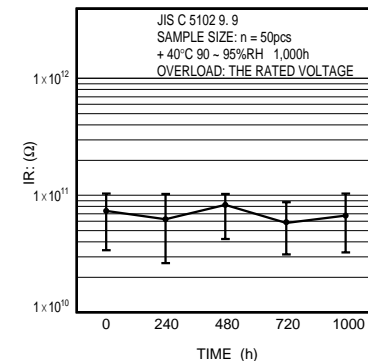

Fig.33 Insulation resistance

*The design and specifications are subject to change without prior notice. Before ordering or using, please check the latest technical specification.