

THREE TERMINAL NEGATIVE VOLTAGE REGULATORS

DESCRIPTION

The μ PC79L00 series are monolithic three terminal negative voltage regulators fixed output voltages of -5 V , -8 V , -12 V , -15 V with output current capabilities in excess of 100 mA . These devices employ internally current limiting, thermal shutdown, and safe-area compensation, make them essentially indestructible. They are intended as fixed voltage regulators in a wide range of application including local (on-card) regulator for elimination of distribution problems associated with single point regulation.

FEATURES

- Output current in excess of 0.1 A .
- Internal thermal overload protection.
- Internal short circuit current limiting.
- Low noise : $31\ \mu\text{V}_{\text{r.m.s.}}$ (μ PC79L05)
- High Ripple Rejection : 85 dB (μ PC79L05)

CONNECTION DIAGRAM

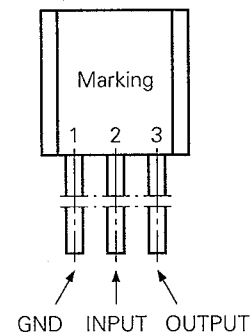

ORDER INFORMATION

TYPE NUMBER	OUTPUT VOLTAGE	PACKAGE	QUALITY GRADE
μ PC79L05J	-5 V	TO-92	Standard
μ PC79L08J	-8 V		
μ PC79L12J	-12 V		
μ PC79L15J	-15 V		

Please refer to "Quality grade on NEC Semiconductor Devices" (Document number IEI-1209) published by NEC Corporation to know the specification of quality grade on the devices and its recommended applications.

EQUIVALENT CIRCUIT

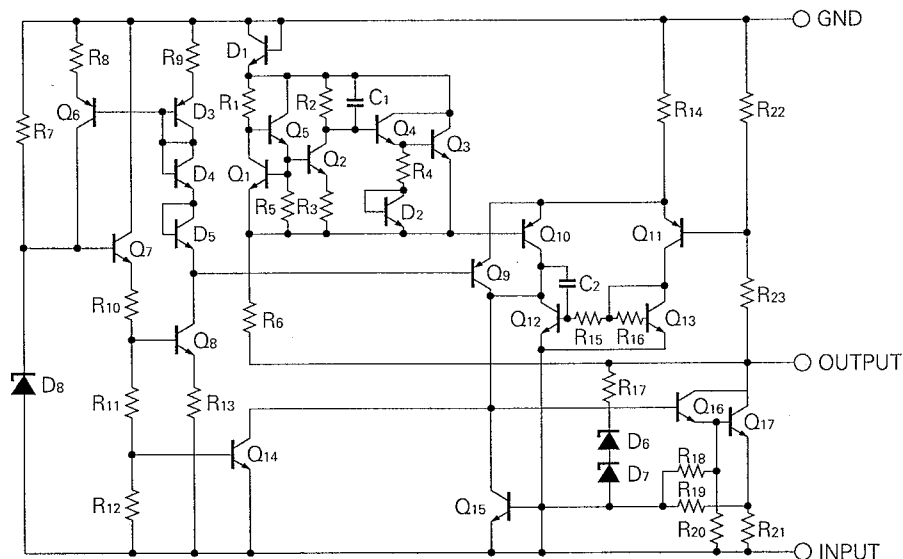

ABSOLUTE MAXIMUM RATINGS (T_a = 25 °C)

ITEM	SYMBOL	RATINGS	UNIT
Input Voltage	V _{IN}	-30/-35 (Note1)	V
Internal Power Dissipation	P _T	700	mW
Operating Ambient Temperature Range	T _{opt}	-20 to +85	°C
Operating Junction Temperature Range	T _{opt (j)}	-20 to +150	°C
Storage Temperature Range	T _{stg}	-55 to +150	°C
Thermal Resistance (junction to case)	R _{th (j-a)}	180	°C/W

(Note 1) μPC79L05, 08 : -30 V, μPC79L12, 15 : -35 V

TYPICAL CONNECTION

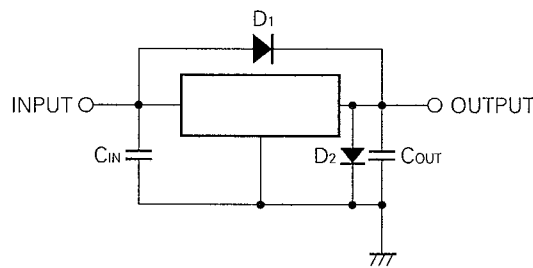

C_{IN}: Required if regulator is located an appreciable distance from power supply filter (More than 2.2 μF)

C_{OUT}: More than 1 μF

D₁: Needed for V_{IN} > V_O

D₂: Needed for V_O > GND

RECOMMENDED OPERATING CONDITIONS

ITEM	SYMBOL	TYPE NUMBER	MIN.	TYP.	MAX.	UNIT
Input Voltage	V _{IN}	μPC79L05	-7	-10	-20	V
		μPC79L08	-10.5	-14	-23	
		μPC79L12	-14.5	-19	-27	
		μPC79L15	-17.5	-23	-30	
Output Current	I _O	All	0	40	70	mA
Operating Temperature Range	T _{opt}	All	-20		+85	°C
Operating Junction Temperature Range	T _{opt (j)}	All	-20		+125	°C

ELECTRICAL CHARACTERISTICS μ PC79L05

($V_{IN} = -10\text{ V}$, $I_o = 40\text{ mA}$, $0\text{ }^\circ\text{C} \leq T_j \leq 125\text{ }^\circ\text{C}$, $C_{IN} = 2.2\text{ }\mu\text{F}$, $C_{OUT} = 1\text{ }\mu\text{F}$)

CHARACTERISTIC	SYMBOL	TEST CONDITIONS	MIN.	TYP.	MAX.	UNIT
Output Voltage	V_o	$T_j = 25\text{ }^\circ\text{C}$	-4.8	-5.0	-5.2	V
		$-7\text{ V} \leq V_{IN} \leq -20\text{ V}$, $1\text{ mA} \leq I_o \leq 40\text{ mA}$	-4.75		-5.25	
Line Regulation	REG _{IN}	$T_j = 25\text{ }^\circ\text{C}$, $-7\text{ V} \leq V_{IN} \leq -20\text{ V}$		3	60	mV
Load Regulation	REG _L	$T_j = 25\text{ }^\circ\text{C}$, $1\text{ mA} \leq I_o \leq 100\text{ mA}$		10	50	mV
Quiescent Current	I_{BIAS}	$T_j = 25\text{ }^\circ\text{C}$		4.2	6.0	mA
Quiescent Current Change	ΔI_{BIAS}	$-7\text{ V} \leq V_{IN} \leq -20\text{ V}$, $I_o = 40\text{ mA}$			0.5	mA
		$V_{IN} = -10\text{ V}$, $1\text{ mA} \leq I_o \leq 40\text{ mA}$			0.1	
Output Noise Voltage	V_n	$T_j = 25\text{ }^\circ\text{C}$, $10\text{ Hz} \leq f \leq 100\text{ kHz}$		31	200	$\mu\text{V}_{r.m.s.}$
Ripple Rejection	R-R	$T_j = 25\text{ }^\circ\text{C}$, $-8\text{ V} \leq V_{IN} \leq -18\text{ V}$, $f = 120\text{ Hz}$	65	85		dB
Dropout Voltage	V_{DIF}	$T_j = 25\text{ }^\circ\text{C}$		0.9		V
Short Circuit Current	$I_{O\text{ short}}$	$T_j = 25\text{ }^\circ\text{C}$, $V_{IN} = -20\text{ V}$		95		mA
Peak Output Current	$I_{O\text{ peak}}$	$T_j = 25\text{ }^\circ\text{C}$	140	190	230	mA
Temperature Coefficient of Output Voltage	$\Delta V_o/\Delta T$	$I_o = 5\text{ mA}$		0.4		mV/ $^\circ\text{C}$

ELECTRICAL CHARACTERISTICS μ PC79L08

($V_{IN} = -14\text{ V}$, $I_o = 40\text{ mA}$, $0\text{ }^\circ\text{C} \leq T_j \leq 125\text{ }^\circ\text{C}$, $C_{IN} = 2.2\text{ }\mu\text{F}$, $C_{OUT} = 1\text{ }\mu\text{F}$)

CHARACTERISTIC	SYMBOL	TEST CONDITIONS	MIN.	TYP.	MAX.	UNIT
Output Voltage	V_o	$T_j = 25\text{ }^\circ\text{C}$	-7.7	-8.0	-8.3	V
		$-10.5\text{ V} \leq V_{IN} \leq -23\text{ V}$, $1\text{ mA} \leq I_o \leq 40\text{ mA}$	-7.6		-8.4	
Line Regulation	REG _{IN}	$T_j = 25\text{ }^\circ\text{C}$, $-10.5\text{ V} \leq V_{IN} \leq -23\text{ V}$		5	60	mV
Load Regulation	REG _L	$T_j = 25\text{ }^\circ\text{C}$, $1\text{ mA} \leq I_o \leq 100\text{ mA}$		12	80	mV
Quiescent Current	I_{BIAS}	$T_j = 25\text{ }^\circ\text{C}$		4.3	6.0	mA
Quiescent Current Change	ΔI_{BIAS}	$-10.5\text{ V} \leq V_{IN} \leq -23\text{ V}$, $I_o = 40\text{ mA}$			0.5	mA
		$V_{IN} = -14\text{ V}$, $1\text{ mA} \leq I_o \leq 40\text{ mA}$			0.1	
Output Noise Voltage	V_n	$T_j = 25\text{ }^\circ\text{C}$, $10\text{ Hz} \leq f \leq 100\text{ kHz}$		56	220	$\mu\text{V}_{r.m.s.}$
Ripple Rejection	R-R	$T_j = 25\text{ }^\circ\text{C}$, $-12\text{ V} \leq V_{IN} \leq -22\text{ V}$, $f = 120\text{ Hz}$	63	75		dB
Dropout Voltage	V_{DIF}	$T_j = 25\text{ }^\circ\text{C}$		0.9		V
Short Circuit Current	$I_{O\text{ short}}$	$T_j = 25\text{ }^\circ\text{C}$, $V_{IN} = -23\text{ V}$		75		mA
Peak Output Current	$I_{O\text{ peak}}$	$T_j = 25\text{ }^\circ\text{C}$	140	190	230	mA
Temperature Coefficient of Output Voltage	$\Delta V_o/\Delta T$	$I_o = 5\text{ mA}$		0.6		mV/ $^\circ\text{C}$

ELECTRICAL CHARACTERISTICS μ PC79L12

($V_{IN} = -19\text{ V}$, $I_o = 40\text{ mA}$, $0\text{ }^\circ\text{C} \leq T_j \leq 125\text{ }^\circ\text{C}$, $C_{IN} = 2.2\text{ }\mu\text{F}$, $C_{OUT} = 1\text{ }\mu\text{F}$)

CHARACTERISTIC	SYMBOL	TEST CONDITIONS	MIN.	TYP.	MAX.	UNIT
Output Voltage	V_o	$T_j = 25\text{ }^\circ\text{C}$	-11.5	-12.0	-12.5	V
		$-14.5\text{ V} \leq V_{IN} \leq -27\text{ V}$, $1\text{ mA} \leq I_o \leq 40\text{ mA}$	-11.4		-12.6	
Line Regulation	REG _{IN}	$T_j = 25\text{ }^\circ\text{C}$, $-14.5\text{ V} \leq V_{IN} \leq -27\text{ V}$		8	45	mV
Load Regulation	REG _L	$T_j = 25\text{ }^\circ\text{C}$, $1\text{ mA} \leq I_o \leq 100\text{ mA}$		15	100	mV
Quiescent Current	I_{BIAS}	$T_j = 25\text{ }^\circ\text{C}$		4.4	6.0	mA
Quiescent Current Change	ΔI_{BIAS}	$-14.5\text{ V} \leq V_{IN} \leq -30\text{ V}$, $I_o = 40\text{ mA}$			0.5	mA
		$V_{IN} = -19\text{ V}$, $1\text{ mA} \leq I_o \leq 40\text{ mA}$			0.1	
Output Noise Voltage	V_n	$T_j = 25\text{ }^\circ\text{C}$, $10\text{ Hz} \leq f \leq 100\text{ kHz}$		88	280	$\mu\text{V}_{r.m.s.}$
Ripple Rejection	R-R	$T_j = 25\text{ }^\circ\text{C}$, $-15\text{ V} \leq V_{IN} \leq -25\text{ V}$, $f = 120\text{ Hz}$	55	70		dB
Dropout Voltage	V_{DIF}	$T_j = 25\text{ }^\circ\text{C}$		0.9		V
Short Circuit Current	$I_{O\ short}$	$T_j = 25\text{ }^\circ\text{C}$, $V_{IN} = -27\text{ V}$		50		mA
Peak Output Current	$I_{O\ peak}$	$T_j = 25\text{ }^\circ\text{C}$	140	190	230	mA
Temperature Coefficient of Output Voltage	$\Delta V_o/\Delta T$	$I_o = 5\text{ mA}$		0.8		mV/ $^\circ\text{C}$

ELECTRICAL CHARACTERISTICS μ PC79L15

($V_{IN} = -23\text{ V}$, $I_o = 40\text{ mA}$, $0\text{ }^\circ\text{C} \leq T_j \leq 125\text{ }^\circ\text{C}$, $C_{IN} = 2.2\text{ }\mu\text{F}$, $C_{OUT} = 1\text{ }\mu\text{F}$)

CHARACTERISTIC	SYMBOL	TEST CONDITIONS	MIN.	TYP.	MAX.	UNIT
Output Voltage	V_o	$T_j = 25\text{ }^\circ\text{C}$	-14.4	-15.0	-15.6	V
		$-17.5\text{ V} \leq V_{IN} \leq -30\text{ V}$, $1\text{ mA} \leq I_o \leq 40\text{ mA}$	-14.25		-15.75	
Line Regulation	REG _{IN}	$T_j = 25\text{ }^\circ\text{C}$, $-17.5\text{ V} \leq V_{IN} \leq -30\text{ V}$		10	45	mV
Load Regulation	REG _L	$T_j = 25\text{ }^\circ\text{C}$, $1\text{ mA} \leq I_o \leq 100\text{ mA}$		20	125	mV
Quiescent Current	I_{BIAS}	$T_j = 25\text{ }^\circ\text{C}$		4.5	6.0	mA
Quiescent Current Change	ΔI_{BIAS}	$-17.5\text{ V} \leq V_{IN} \leq -30\text{ V}$, $I_o = 40\text{ mA}$			0.5	mA
		$V_{IN} = -23\text{ V}$, $1\text{ mA} \leq I_o \leq 40\text{ mA}$			0.1	
Output Noise Voltage	V_n	$T_j = 25\text{ }^\circ\text{C}$, $10\text{ Hz} \leq f \leq 100\text{ kHz}$		100	360	$\mu\text{V}_{r.m.s.}$
Ripple Rejection	R-R	$T_j = 25\text{ }^\circ\text{C}$, $-18.5\text{ V} \leq V_{IN} \leq -28.5\text{ V}$, $f = 120\text{ Hz}$	55	65		dB
Dropout Voltage	V_{DIF}	$T_j = 25\text{ }^\circ\text{C}$		0.9		V
Short Circuit Current	$I_{O\ short}$	$T_j = 25\text{ }^\circ\text{C}$, $V_{IN} = -30\text{ V}$		25		mA
Peak Output Current	$I_{O\ peak}$	$T_j = 25\text{ }^\circ\text{C}$	140	190	230	mA
Temperature Coefficient of Output Voltage	$\Delta V_o/\Delta T$	$I_o = 5\text{ mA}$		1.0		mV/ $^\circ\text{C}$

TYPICAL CHARACTERISTICS ($T_a = 25^\circ\text{C}$)

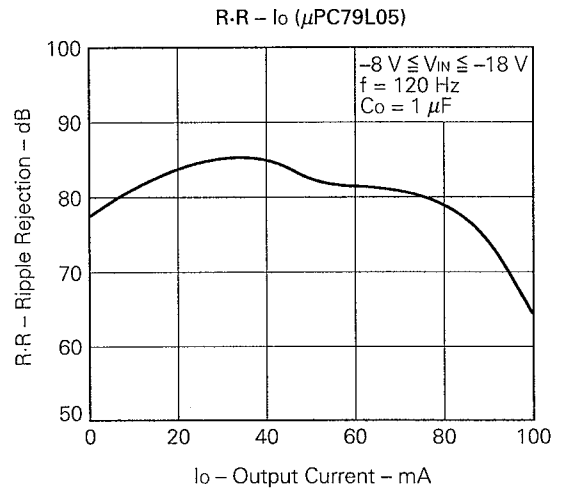
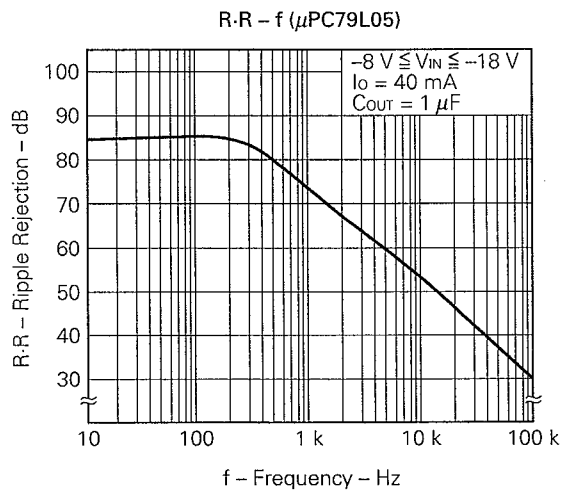
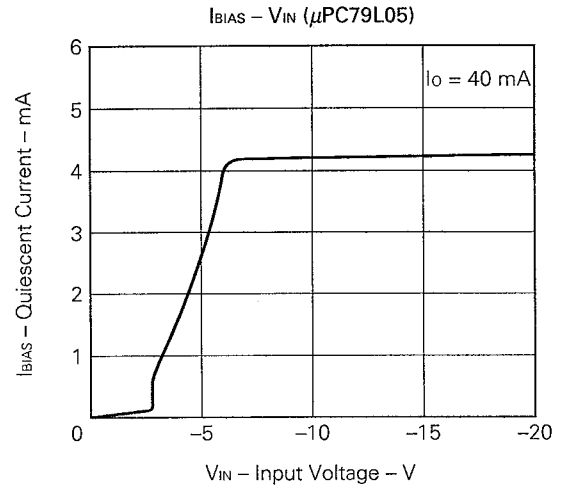
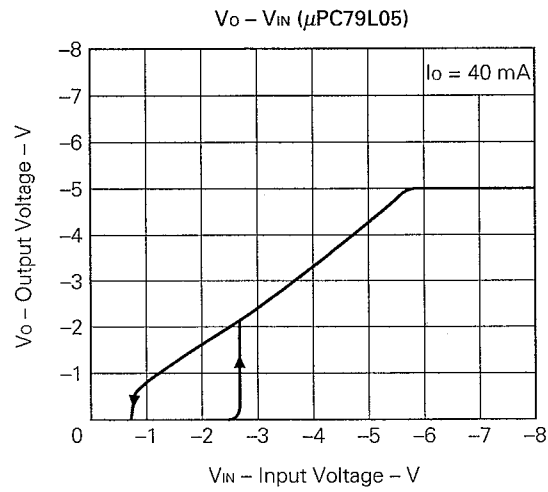
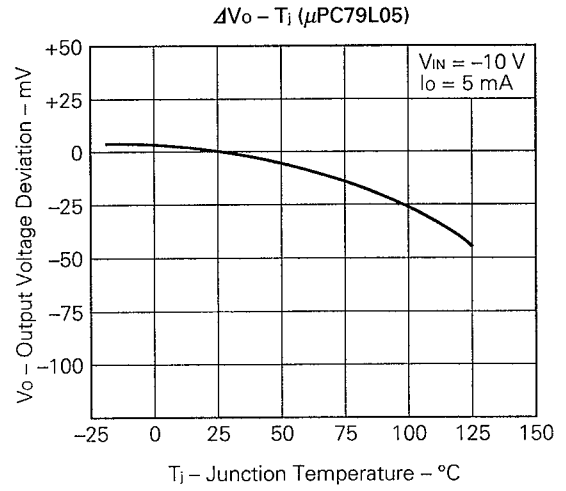
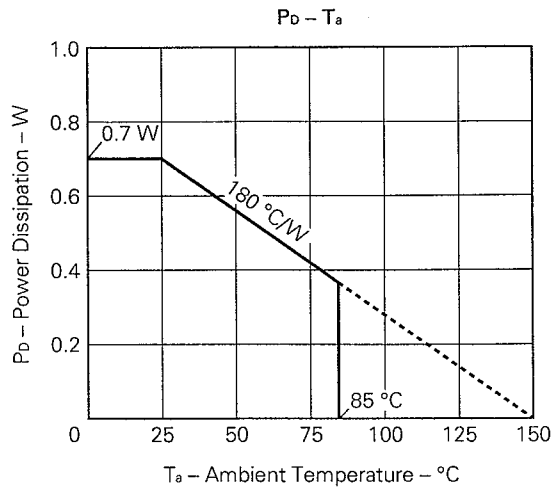

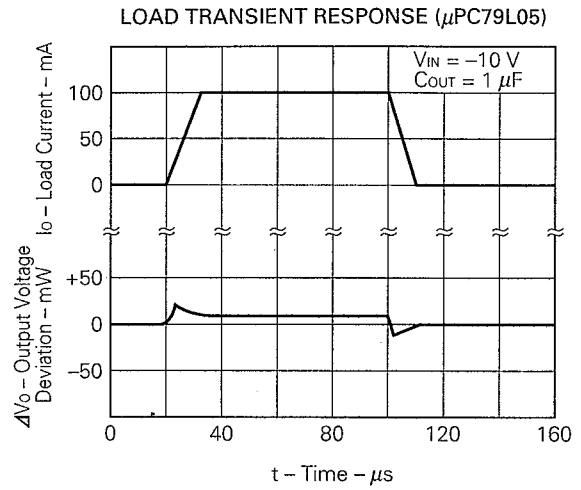
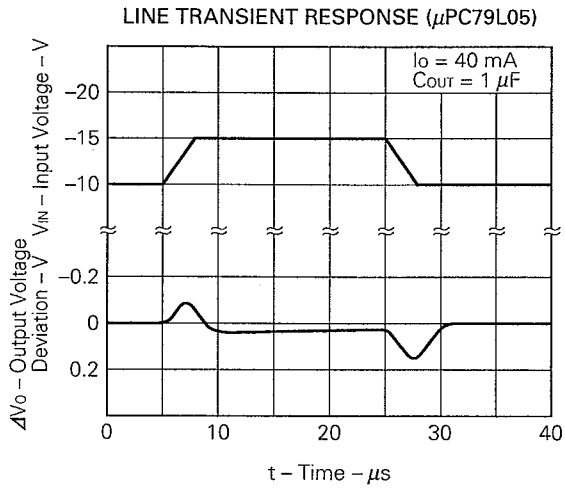
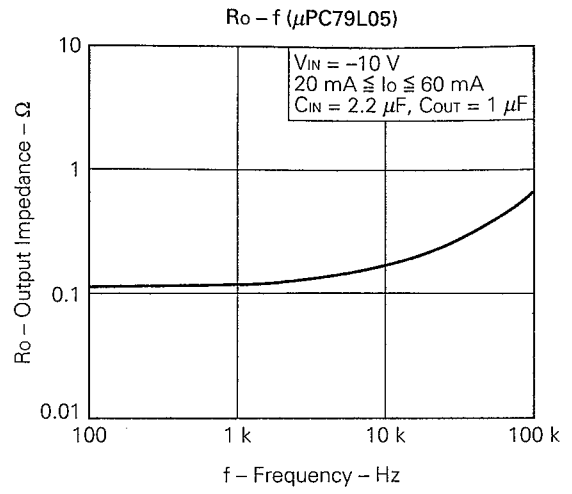
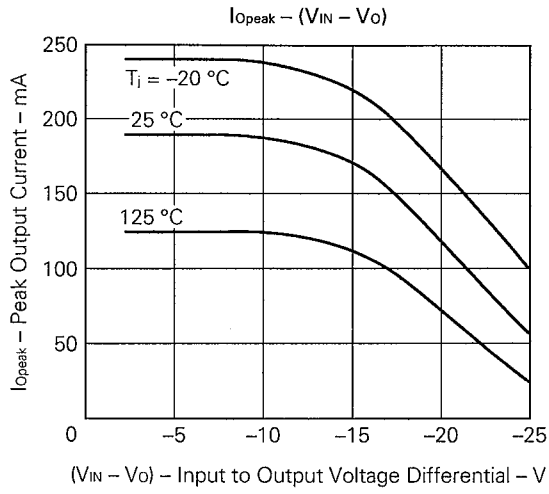

PACKAGE DIMENSIONS (Unit: mm)
3 PIN PLASTIC SIP (TO-92)

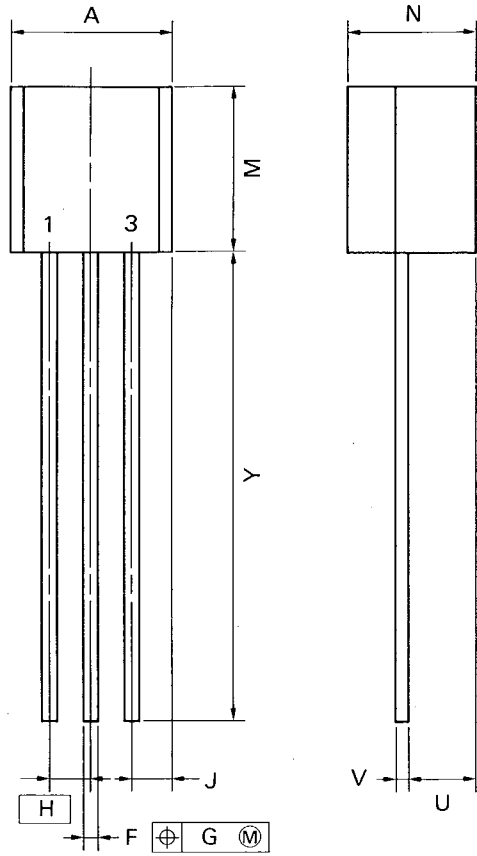

P3J-127B

NOTE

Each lead centerline is located within 0.12 mm (0.005 inch) of its true position (T.P.) at maximum material condition.

ITEM	MILLIMETERS	INCHES
A	5.2 MAX.	0.205 MAX.
F	0.5 ^{+0.1}	0.02 ^{+0.004}
G	0.12	0.005
H	1.27	0.05
J	1.33 MAX.	0.053 MAX.
M	5.5 MAX.	0.217 MAX.
N	4.2 MAX.	0.166 MAX.
U	2.8 MAX.	0.111 MAX.
V	0.5 ^{+0.1}	0.02 ^{+0.004}
Y	15.0 ^{+0.7}	0.591 ^{+0.028}

RECOMMENDED SOLDERING CONDITIONS

The following conditions (see table below) must be met when soldering this product.

Please consult with our sales offices in case other soldering process is used, or in case soldering is done under different conditions.

TYPES OF THROUGH HOLE MOUNT DEVICE

μPC79L00J Series

Soldering process	Soldering conditions	Symbol
Wave soldering	Solder temperature: 260 °C or below. Flow time: 10 seconds or below.	

Reference

Application note name	No.
Quality control of NEC semiconductor devices	TEI-1202
Quality control guide of semiconductor devices	MEI-1202
Assembly manual of semiconductor devices	IEI-1207
NEC semiconductor device reliability/quality control system	IEI-1212

[MEMO]

No part of this document may be copied or reproduced in any form or by any means without the prior written consent of NEC Corporation. NEC Corporation assumes no responsibility for any errors which may appear in this document.

NEC Corporation does not assume any liability for infringement of patents, copyrights or other intellectual property rights of third parties by or arising from use of a device described herein or any other liability arising from use of such device. No license, either express, implied or otherwise, is granted under any patents, copyrights or other intellectual property rights of NEC Corporation or others.

The devices listed in this document are not suitable for use in aerospace equipment, submarine cables, nuclear reactor control systems and life support systems. If customers intend to use NEC devices for above applications or they intend to use "Standard" quality grade NEC devices for applications not intended by NEC, please contact our sales people in advance.

Application examples recommended by NEC Corporation.

Standard: Computer, Office equipment, Communication equipment, Test and Measurement equipment, Machine tools, Industrial robots, Audio and Visual equipment, Other consumer products, etc.

Special: Automotive and Transportation equipment, Traffic control systems, Antidisaster systems, Anticrime systems, etc.