

Rectifier Diodes

100V

V _{RM} (V)	Package	Part Number	I _F (AV) (A) () is with Heatsink	I _{FSM} (A)	T _J (°C)	T _{stg} (°C)	V _F (V) max	I _F (A)	I _R (μA)	I _R (H) (μA)	R _{th} (j-l) R _{th} (j-c) (°C/W)	Mass (g)	Fig. No.	Page where characteristic curve is shown
				50Hz Half-cycle Sinewave Single Shot					V _R = V _{RM} max	V _R = V _{RM} max				
100	Axial	EM 1Y	1.0	45	-40 to +150	0.97	1.0	10	50	100	17	0.3	1	48
		RM 4Y	1.7 (3.0)	200	-40 to +150	0.95	3.0	10	50	100	8	1.2	2	50
	Center-tap	FMM-31S, R	20	120	-40 to +150	1.1	10	10	100	100	2.0	5.5	3	51
	Bridge	RBV-401	4.0	80	-40 to +150	1.05	2.0	10	100	100	5.0	4.05	4	51
		RBV-601	6.0	120	-40 to +150	1.0	3.0	10	100	100	3.0	6.45	5	52

External Dimensions Flammability: UL94V-0 or Equivalent (Unit: mm)

1

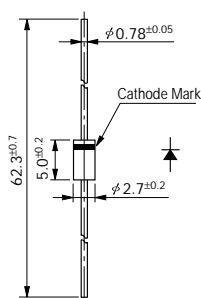

2

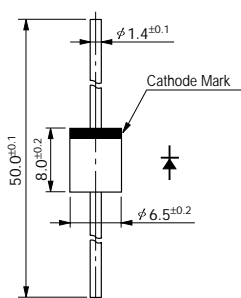

3

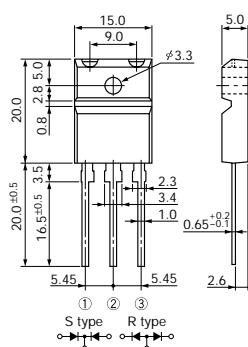

4

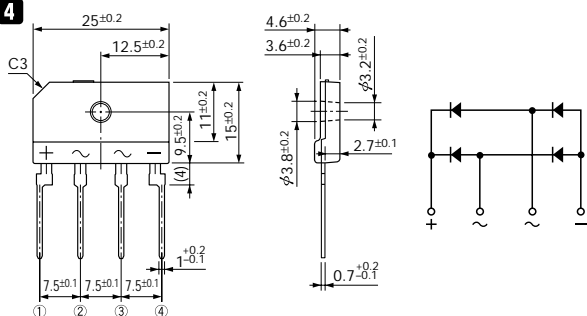

5

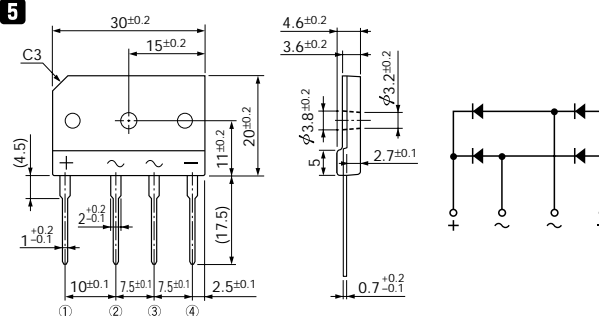

Characteristic Curves Rectifier Diodes

FMM-3 series

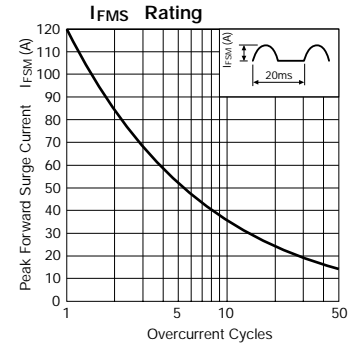
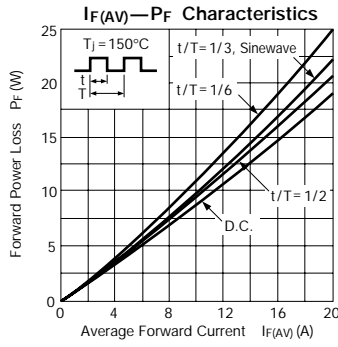
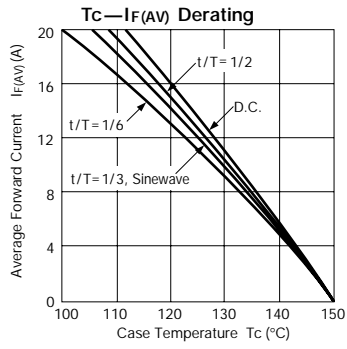

RBV-401, 402

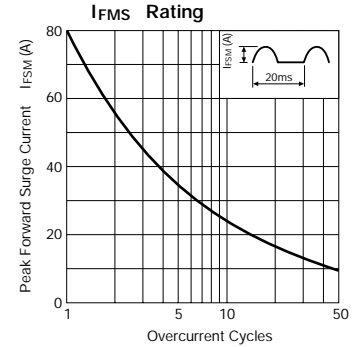
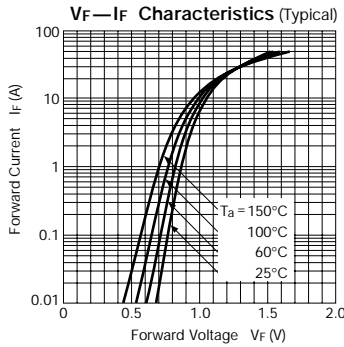
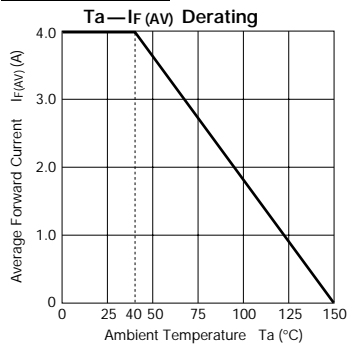

RBV-404, 406

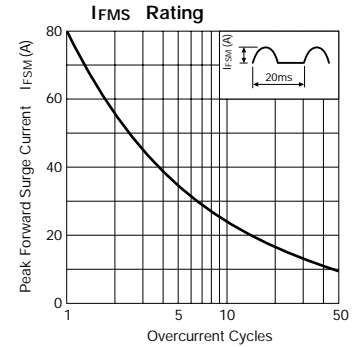
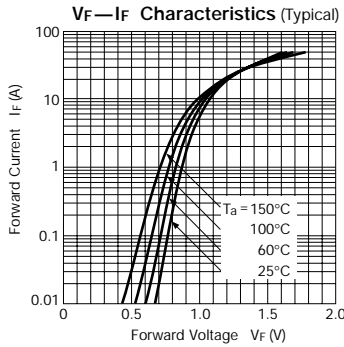
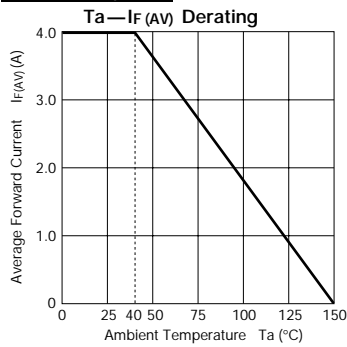

RBV-408, 40C

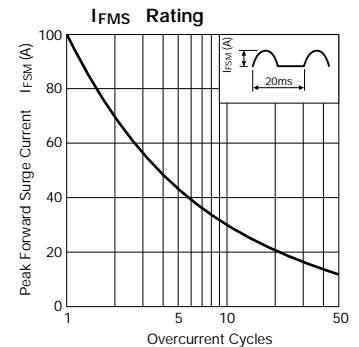
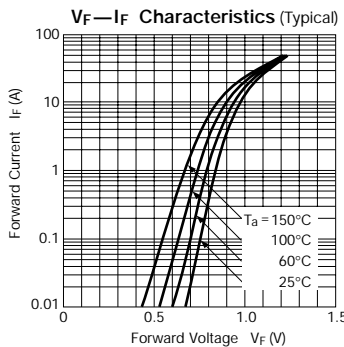
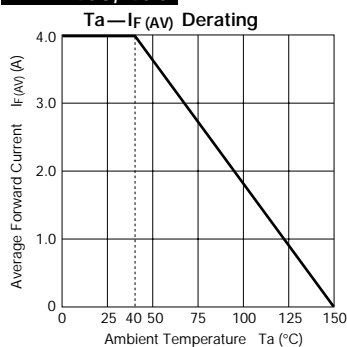

RBV-406M

