

Vertical Type Dual Pin Jacks

Unit: mm

JPJ1151 Series

$\ell = 23.5$ mm

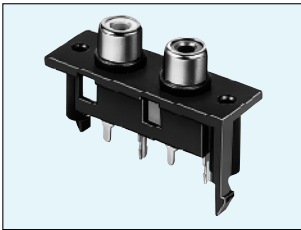

JPJ1151

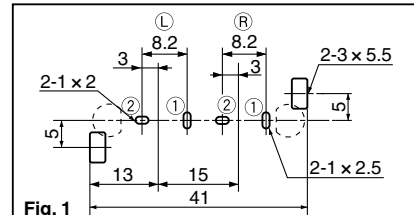
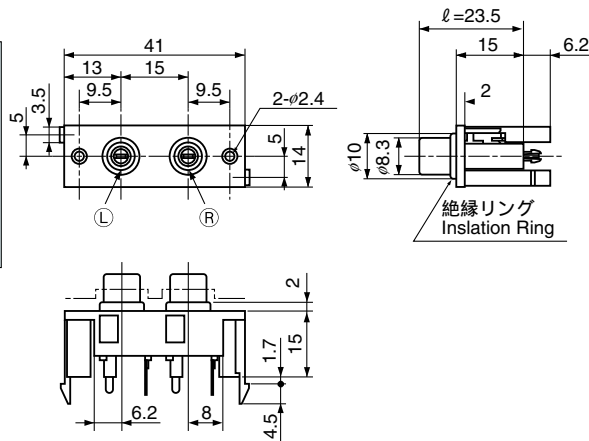

Fig. 1

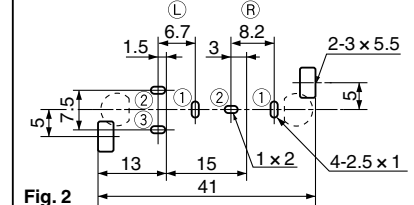

Fig. 2

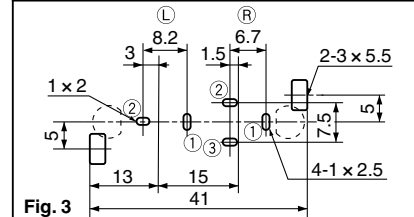

Fig. 3

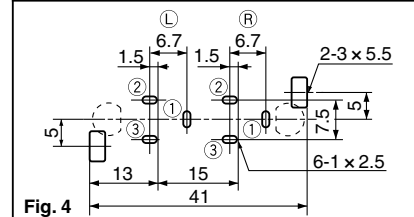

Fig. 4

Schematic L R	Insulation Ring		Hole Layout (Bottom view)
	With	Without	
	JPJ1151-01-L R 0	JPJ1161-01-L R 0	Fig. 1
	JPJ1154-01-L R 0	JPJ1164-01-L R 0	Fig. 2
	JPJ1153-01-L R 0	JPJ1163-01-L R 0	Fig. 3
	JPJ1152-010 L R 0	JPJ1162-01-L R 0	Fig. 4

L & R indicate pin jack color No. below.

Color No.	
1	Black
2	Red
3	White
4	Yellow
5	Blue

JPJ2052 Series

$\ell = 19.5$ mm

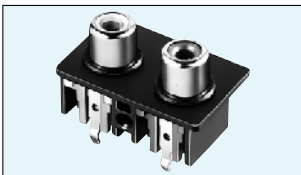

JPJ2052

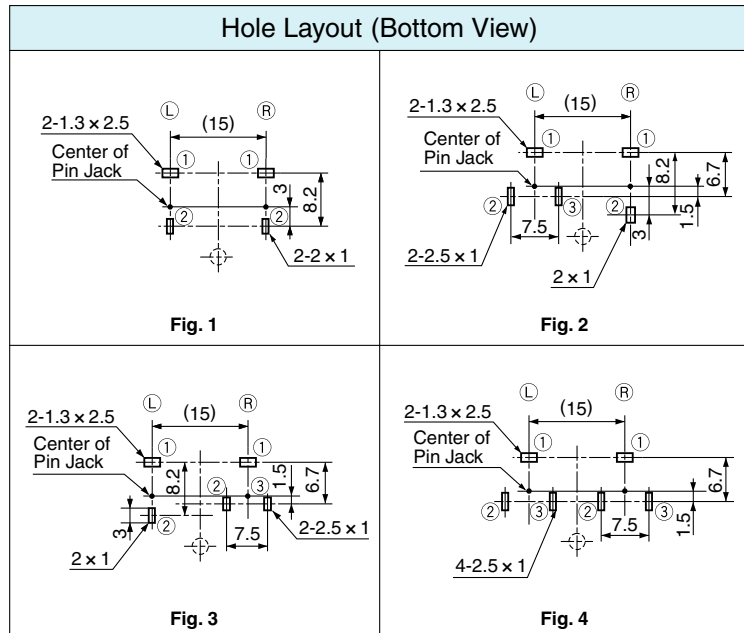
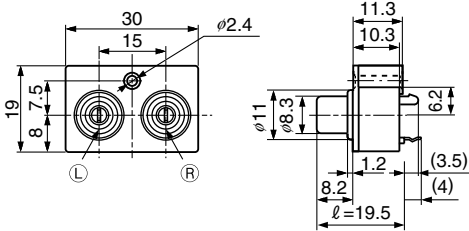

Fig. 1

Fig. 2

Fig. 3

Fig. 4

Schematic L R	Model No.	Hole Layout (Bottom view)
	JPJ2052-01-L R 0	Fig. 1
	JPJ2051-01-L R 0	Fig. 2
	JPJ1051-01-L R 0	Fig. 3
	JPJ1052-01-L R 0	Fig. 4

L & R indicate pin jack color No. below.

Color No.	
1	Black
2	Red
3	White
4	Yellow
5	Blue