

LM6181 100 mA, 100 MHz Current Feedback Amplifier

General Description

The LM6181 current-feedback amplifier offers an unparalleled combination of bandwidth, slew-rate, and output current. The amplifier can directly drive up to 100 pF capacitive loads without oscillating and a 10V signal into a 50Ω or 75Ω back-terminated coax cable system over the full industrial temperature range. This represents a radical enhancement in output drive capability for an 8-pin DIP high-speed amplifier making it ideal for video applications.

Built on National's advanced high-speed VIPTM II (Vertically Integrated PNP) process, the LM6181 employs current-feedback providing bandwidth that does not vary dramatically with gain; 100 MHz at $A_V = -1$, 60 MHz at $A_V = -10$. With a slew rate of 2000V/μs, 2nd harmonic distortion of -50 dBc at 10 MHz and settling time of 50 ns (0.1%) the LM6181 dynamic performance makes it ideal for data acquisition, high speed ATE, and precision pulse amplifier applications.

Features (Typical unless otherwise noted)

- Slew rate 2000 V/μs
- Settling time (0.1%) 50 ns
- Characterized for supply ranges ±5V and ±15V
- Low differential gain and phase error 0.05%, 0.04°
- High output drive ±10V into 100Ω
- Guaranteed bandwidth and slew rate
- Improved performance over EL2020, OP160, AD844, LT1223 and HA5004

Applications

- Coax cable driver
- Video amplifier
- Flash ADC buffer
- High frequency filter
- Scanner and Imaging systems

Typical Application

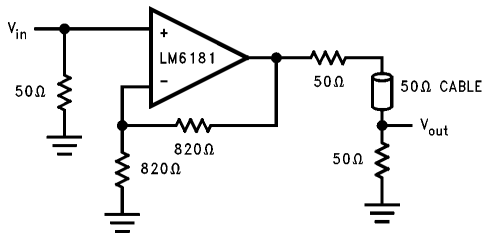

Cable Driver

TL/H/11328-1

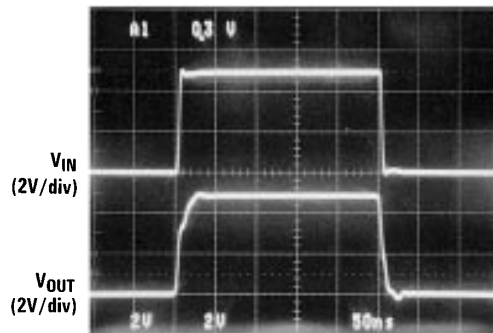

TIME (50ns/div)

TL/H/11328-2

Connection Diagrams (For Ordering Information See Back Page)

8-Pin Dual-In-Line Package (N)/ Small Outline (M-8)

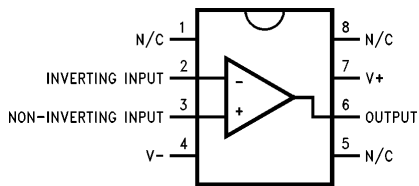

TL/H/11328-3

Order Number LM6181IN, LM6181AIN, LM6181AMN, LM6181AIM-8, LM6181IM-8 or LM6181AMJ/883

See NS Package Number J08A, M08A or N08E

16-Pin Small Outline Package (M)

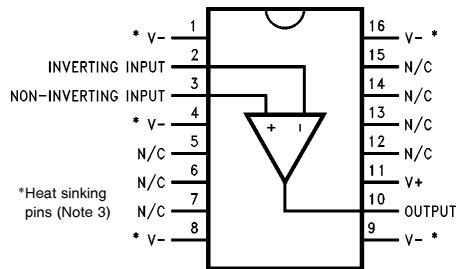

TL/H/11328-4

Order Number LM6181IM or LM6181AIM See NS Package Number M16A

VIPTM is a registered trademark of National Semiconductor Corporation.

Absolute Maximum Ratings (Note 1)

If Military/Aerospace specified devices are required, please contact the National Semiconductor Sales Office/Distributors for availability and specifications.

Supply Voltage	±18V
Differential Input Voltage	±6V
Input Voltage	± Supply Voltage
Inverting Input Current	15 mA
Soldering Information	
Dual-In-Line Package (N) Soldering (10 sec)	260°C
Small Outline Package (M)	
Vapor Phase (60 seconds)	215°C
Infrared (15 seconds)	220°C

Output Short Circuit	(Note 7)
Storage Temperature Range	-65°C ≤ T _J ≤ +150°C
Maximum Junction Temperature	150°C
ESD Rating (Note 2)	±3000V

Operating Ratings

Supply Voltage Range	7V to 32V
Junction Temperature Range (Note 3)	
LM6181AM	-55°C ≤ T _J ≤ +125°C
LM6181AI, LM6181I	-40°C ≤ T _J ≤ +85°C
Thermal Resistance (θ _{JA} , θ _{JC})	
8-pin DIP (N)	102°C/W, 42°C/W
8-pin SO (M-8)	153°C/W, 42°C/W
16-pin SO (M)	70°C/W, 38°C/W

±15V DC Electrical Characteristics

The following specifications apply for Supply Voltage = ±15V, R_F = 820Ω, and R_L = 1 kΩ unless otherwise noted. **Boldface** limits apply at the temperature extremes; all other limits T_J = 25°C.

Symbol	Parameter	Conditions	LM6181AM		LM6181AI		LM6181I		Units
			Typical (Note 4)	Limit (Note 5)	Typical (Note 4)	Limit (Note 5)	Typical (Note 4)	Limit (Note 5)	
V _{OS}	Input Offset Voltage		2.0	3.0 4.0	2.0	3.0 3.5	3.5	5.0 5.5	mV max
TC V _{OS}	Input Offset Voltage Drift		5.0		5.0		5.0		μV/°C
I _B	Inverting Input Bias Current		2.0	5.0 12.0	2.0	5.0 12.0	5.0	10 17.0	μA max
	Non-Inverting Input Bias Current		0.5	1.5 3.0	0.5	1.5 3.0	2.0	3.0 5.0	
TC I _B	Inverting Input Bias Current Drift		30		30		30		nA/°C
	Non-Inverting Input Bias Current Drift		10		10		10		
I _B PSR	Inverting Input Bias Current Power Supply Rejection	V _S = ±4.5V, ±16V	0.3	0.5 3.0	0.3	0.5 3.0	0.3	0.75 4.5	μA/V max
	Non-Inverting Input Bias Current Power Supply Rejection	V _S = ±4.5V, ±16V	0.05	0.5 1.5	0.05	0.5 1.5	0.05	0.5 3.0	
I _B CMR	Inverting Input Bias Current Common Mode Rejection	-10V ≤ V _{CM} ≤ +10V	0.3	0.5 0.75	0.3	0.5 0.75	0.3	0.75 1.0	μA/V max
	Non-Inverting Input Bias Current Common Mode Rejection	-10V ≤ V _{CM} ≤ +10V	0.1	0.5 0.5	0.1	0.5 0.5	0.1	0.5 0.5	
CMRR	Common Mode Rejection Ratio	-10V ≤ V _{CM} ≤ +10V	60	50 50	60	50 50	60	50 50	dB min
PSRR	Power Supply Rejection Ratio	V _S = ±4.5V, ±16V	80	70 70	80	70 70	80	70 65	dB min
R _O	Output Resistance	A _V = -1, f = 300 kHz	0.2		0.2		0.2		Ω
R _{IN}	Non-Inverting Input Resistance		10		10		10		MΩ min
V _O	Output Voltage Swing	R _L = 1 kΩ	12	11 11	12	11 11	12	11 11	V min
		R _L = 100Ω	11	10 7.5	11	10 8.0	11	10 8.0	
I _{SC}	Output Short Circuit Current		130	100 75	130	100 85	130	100 85	mA min

± 15V DC Electrical Characteristics (Continued)

The following specifications apply for Supply Voltage = ±15V, $R_F = 820\Omega$, and $R_L = 1\text{ k}\Omega$ unless otherwise noted. **Boldface** limits apply at the temperature extremes; all other limits $T_J = 25^\circ\text{C}$.

Symbol	Parameter	Conditions	LM6181AM		LM6181AI		LM6181I		Units
			Typical (Note 4)	Limit (Note 5)	Typical (Note 4)	Limit (Note 5)	Typical (Note 4)	Limit (Note 5)	
Z_T	Transimpedance	$R_L = 1\text{ k}\Omega$	1.8	1.0 0.5	1.8	1.0 0.5	1.8	0.8 0.4	$M\Omega$ min
		$R_L = 100\Omega$	1.4	0.8 0.4	1.4	0.8 0.4	1.4	0.7 0.35	
I_S	Supply Current	No Load, $V_O = 0V$	7.5	10 10	7.5	10 10	7.5	10 10	mA max
V_{CM}	Input Common Mode Voltage Range		$V^+ - 1.7V$ $V^- + 1.7V$		$V^+ - 1.7V$ $V^- + 1.7V$		$V^+ - 1.7V$ $V^- + 1.7V$		V

± 15V AC Electrical Characteristics

The following specifications apply for Supply Voltage = ±15V, $R_F = 820\Omega$, $R_L = 1\text{ k}\Omega$ unless otherwise noted. **Boldface** limits apply at the temperature extremes; all other limits $T_J = 25^\circ\text{C}$.

Symbol	Parameter	Conditions	LM6181AM		LM6181AI		LM6181I		Units
			Typical (Note 4)	Limit (Note 5)	Typical (Note 4)	Limit (Note 5)	Typical (Note 4)	Limit (Note 5)	
BW	Closed Loop Bandwidth -3 dB	$A_V = +2$	100		100		100		MHz min
		$A_V = +10$	80		80		80		
		$A_V = -1$	100	80	100	80	100	80	
		$A_V = -10$	60		60		60		
PBW	Power Bandwidth	$A_V = -1$, $V_O = 5\text{ V}_{PP}$	60		60		60		
SR	Slew Rate	Overdriven	2000		2000		2000		$V/\mu s$ min
		$A_V = -1$, $V_O = \pm 10V$, $R_L = 150\Omega$ (Note 6)	1400	1000	1400	1000	1400	1000	
t_s	Settling Time (0.1%)	$A_V = -1$, $V_O = \pm 5V$ $R_L = 150\Omega$	50		50		50		ns
t_r, t_f	Rise and Fall Time	$V_O = 1\text{ V}_{PP}$	5		5		5		
t_p	Propagation Delay Time	$V_O = 1\text{ V}_{PP}$	6		6		6		
$i_{n(+)}$	Non-Inverting Input Noise Current Density	$f = 1\text{ kHz}$	3		3		3		
$i_{n(-)}$	Inverting Input Noise Current Density	$f = 1\text{ kHz}$	16		16		16		pA/\sqrt{Hz}
e_n	Input Noise Voltage Density	$f = 1\text{ kHz}$	4		4		4		nV/\sqrt{Hz}
	Second Harmonic Distortion	2 V_{PP} , 10 MHz	-50		-50		-50		
	Third Harmonic Distortion	2 V_{PP} , 10 MHz	-55		-55		-55		
	Differential Gain	$R_L = 150\Omega$ $A_V = +2$ NTSC	0.05		0.05		0.05		%
	Differential Phase	$R_L = 150\Omega$ $A_V = +2$ NTSC	0.04		0.04		0.04		Deg

±5V DC Electrical Characteristics

The following specifications apply for Supply Voltage = ±5V, $R_F = 820\Omega$, and $R_L = 1\text{ k}\Omega$ unless otherwise noted. **Boldface** limits apply at the temperature extremes; all other limits $T_J = 25^\circ\text{C}$.

Symbol	Parameter	Conditions	LM6181AM		LM6181AI		LM6181I		Units
			Typical (Note 4)	Limit (Note 5)	Typical (Note 4)	Limit (Note 5)	Typical (Note 4)	Limit (Note 5)	
V_{OS}	Input Offset Voltage		1.0	2.0 3.0	1.0	2.0 2.5	1.0	3.0 3.5	mV max
$TC V_{OS}$	Input Offset Voltage Drift		2.5		2.5		2.5		$\mu\text{V}/^\circ\text{C}$
I_B	Inverting Input Bias Current		5.0	10 22	5.0	10 22	5.0	17.5 27.0	μA max
	Non-Inverting Input Bias Current		0.25	1.5 1.5	0.25	1.5 1.5	0.25	3.0 5.0	
$TC I_B$	Inverting Input Bias Current Drift		50		50		50		nA/ $^\circ\text{C}$
	Non-Inverting Input Bias Current Drift		3.0		3.0		3.0		
I_B PSR	Inverting Input Bias Current Power Supply Rejection	$V_S = \pm 4.0\text{V}, \pm 6.0\text{V}$	0.3	0.5 0.5	0.3	0.5 0.5	0.3	1.0 1.0	$\mu\text{A}/\text{V}$ max
	Non-Inverting Input Bias Current Power Supply Rejection	$V_S = \pm 4.0\text{V}, \pm 6.0\text{V}$	0.05	0.5 0.5	0.05	0.5 0.5	0.05	0.5 0.5	
I_B CMR	Inverting Input Bias Current Common Mode Rejection	$-2.5\text{V} \leq V_{CM} \leq +2.5\text{V}$	0.3	0.5 1.0	0.3	0.5 1.0	0.3	1.0 1.5	$\mu\text{A}/\text{V}$ max
	Non-Inverting Input Bias Current Common Mode Rejection	$-2.5\text{V} \leq V_{CM} \leq +2.5\text{V}$	0.12	0.5 1.0	0.12	0.5 0.5	0.12	0.5 0.5	
CMRR	Common Mode Rejection Ratio	$-2.5\text{V} \leq V_{CM} \leq +2.5\text{V}$	57	50 47	57	50 47	57	50 47	dB
PSRR	Power Supply Rejection Ratio	$V_S = \pm 4.0\text{V}, \pm 6.0\text{V}$	80	70 70	80	70 70	80	64 64	min
R_O	Output Resistance	$A_V = -1, f = 300\text{ kHz}$	0.25		0.25		0.25		Ω
R_{IN}	Non-Inverting Input Resistance		8		8		8		M Ω min
V_O	Output Voltage Swing	$R_L = 1\text{ k}\Omega$	2.6	2.25 2.2	2.6	2.25 2.25	2.6	2.25 2.25	V min
		$R_L = 100\Omega$	2.2	2.0 2.0	2.2	2.0 2.0	2.2	2.0 2.0	
I_{SC}	Output Short Circuit Current		100	75 70	100	75 70	100	75 70	mA min
Z_T	Transimpedance	$R_L = 1\text{ k}\Omega$	1.4	0.75 0.35	1.4	0.75 0.4	1.0	0.6 0.3	M Ω min
		$R_L = 100\Omega$	1.0	0.5 0.25	1.0	0.5 0.25	1.0	0.4 0.2	
I_S	Supply Current	No Load, $V_O = 0\text{V}$	6.5	8.5 8.5	6.5	8.5 8.5	6.5	8.5 8.5	mA max
V_{CM}	Input Common Mode Voltage Range		$V^+ - 1.7\text{V}$ $V^- + 1.7\text{V}$		$V^+ - 1.7\text{V}$ $V^- + 1.7\text{V}$		$V^+ - 1.7\text{V}$ $V^- + 1.7\text{V}$		V

± 5V AC Electrical Characteristics

The following specifications apply for Supply Voltage = ±5V, $R_F = 820\Omega$, and $R_L = 1\text{ k}\Omega$ unless otherwise noted. **Boldface** limits apply at the temperature extremes; all other limits $T_J = 25^\circ\text{C}$.

Symbol	Parameter	Conditions	LM6181AM		LM6181AI		LM6181I		Units
			Typical (Note 4)	Limit (Note 5)	Typical (Note 4)	Limit (Note 5)	Typical (Note 4)	Limit (Note 5)	
BW	Closed Loop Bandwidth –3 dB	$A_V = +2$	50		50		50		MHz min
		$A_V = +10$	40		40		40		
		$A_V = -1$	55	35	55	35	55	35	
		$A_V = -10$	35		35		35		
PBW	Power Bandwidth	$A_V = -1, V_O = 4 V_{PP}$	40		40		40		
SR	Slew Rate	$A_V = -1, V_O = \pm 2V, R_L = 150\Omega$ (Note 6)	500	375	500	375	500	375	V/ μs min
t_s	Settling Time (0.1%)	$A_V = -1, V_O = \pm 2V, R_L = 150\Omega$	50		50		50		ns
t_r, t_f	Rise and Fall Time	$V_O = 1 V_{PP}$	8.5		8.5		8.5		
t_p	Propagation Delay Time	$V_O = 1 V_{PP}$	8		8		8		
$i_{n(+)}$	Non-Inverting Input Noise Current Density	$f = 1\text{ kHz}$	3		3		3		pA/ $\sqrt{\text{Hz}}$
$i_{n(-)}$	Inverting Input Noise Current Density	$f = 1\text{ kHz}$	16		16		16		pA/ $\sqrt{\text{Hz}}$
e_n	Input Noise Voltage Density	$f = 1\text{ kHz}$	4		4		4		nV/ $\sqrt{\text{Hz}}$
	Second Harmonic Distortion	$2 V_{PP}, 10\text{ MHz}$	-45		-45		-45		dBc
	Third Harmonic Distortion	$2 V_{PP}, 10\text{ MHz}$	-55		-55		-55		
	Differential Gain	$R_L = 150\Omega, A_V = +2, \text{NTSC}$	0.063		0.063		0.063		%
	Differential Phase	$R_L = 150\Omega, A_V = +2, \text{NTSC}$	0.16		0.16		0.16		Deg

Note 1: Absolute Maximum Ratings indicate limits beyond which damage to the device may occur. Operating ratings indicate conditions the device is intended to be functional, but device parameter specifications may not be guaranteed under these conditions. For guaranteed specifications and test conditions, see the Electrical Characteristics.

Note 2: Human body model 100 pF and 1.5 k Ω .

Note 3: The typical junction-to-ambient thermal resistance of the molded plastic DIP(N) package soldered directly into a PC board is 102°C/W. The junction-to-ambient thermal resistance of the S.O. surface mount (M) package mounted flush to the PC board is 70°C/W when pins 1, 4, 8, 9 and 16 are soldered to a total 2 in² 1 oz. copper trace. The 16-pin S.O. (M) package must have pin 4 and at least one of pins 1, 8, 9, or 16 connected to V^- for proper operation. The typical junction-to-ambient thermal resistance of the S.O. (M-8) package soldered directly into a PC board is 153°C/W.

Note 4: Typical values represent the most likely parametric norm.

Note 5: All limits guaranteed at room temperature (standard type face) or at operating temperature extremes (**bold face type**).

Note 6: Measured from +25% to +75% of output waveform.

Note 7: Continuous short circuit operation at elevated ambient temperature can result in exceeding the maximum allowed junction temperature of 150°C. Output currents in excess of ±130 mA over a long term basis may adversely affect reliability.

Note 8: For guaranteed Military Temperature Range parameters see RETS6181X.

Typical Performance Characteristics $T_A = 25^\circ\text{C}$ unless otherwise noted

**CLOSED-LOOP
FREQUENCY RESPONSE**
 $V_S = \pm 15\text{V}; R_f = 820\Omega;$
 $R_L = 1\text{ k}\Omega$

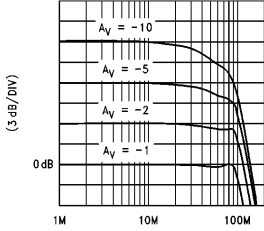

**CLOSED-LOOP
FREQUENCY RESPONSE**
 $V_S = \pm 15\text{V}; R_f = 820\Omega;$
 $R_L = 150\Omega$

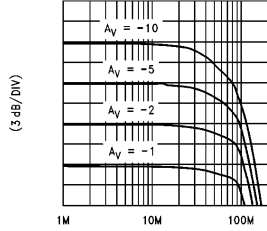

**UNITY GAIN
FREQUENCY RESPONSE**
 $V_S = \pm 15\text{V}; A_V = +1;$
 $R_f = 820\Omega$

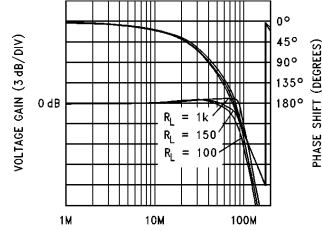

**UNIT GAIN
FREQUENCY RESPONSE**
 $V_S = \pm 5\text{V}; A_V = +1;$
 $R_f = 820\Omega$

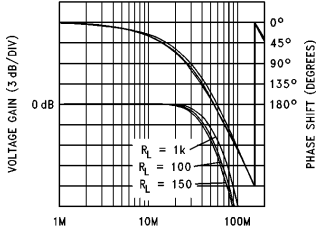

**FREQUENCY RESPONSE
vs SUPPLY VOLTAGE**
 $A_V = -1; R_f = 820\Omega;$
 $R_L = 1\text{ k}\Omega$

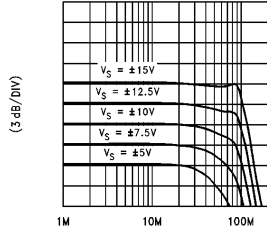

**FREQUENCY RESPONSE
vs SUPPLY VOLTAGE**
 $A_V = -1; R_f = 820\Omega;$
 $R_L = 150\Omega$

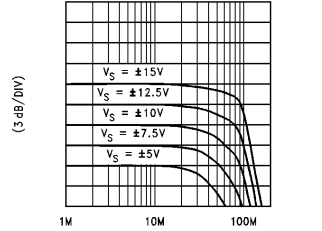

**INVERTING GAIN
FREQUENCY RESPONSE**
 $V_S = \pm 15\text{V}; A_V = -1;$
 $R_f = 820\Omega$

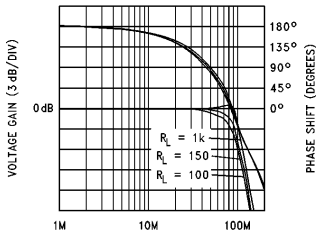

**INVERTING GAIN
FREQUENCY RESPONSE**
 $V_S = \pm 5\text{V}; A_V = -1;$
 $R_f = 820\Omega$

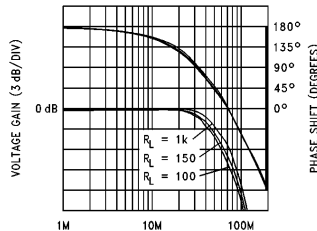

**NON-INVERTING GAIN
FREQUENCY RESPONSE**
 $V_S = \pm 15\text{V}; A_V = +2;$
 $R_f = 820\Omega$

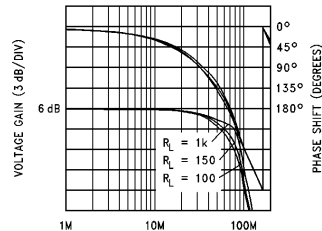

**NON-INVERTING GAIN
FREQUENCY RESPONSE**
 $V_S = \pm 5\text{V}; A_V = +2;$
 $R_f = 820\Omega$

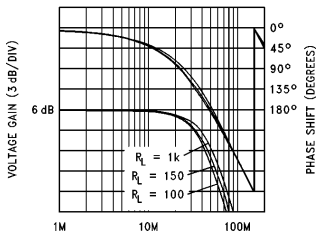

**INVERTING GAIN
FREQUENCY RESPONSE**
 $V_S = \pm 15\text{V}; A_V = -10;$
 $R_f = 820\Omega$

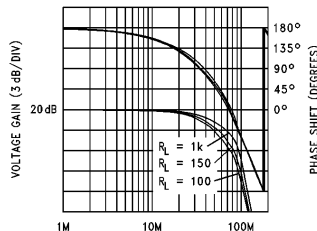

**INVERTING GAIN
FREQUENCY RESPONSE**
 $V_S = \pm 5\text{V}; A_V = -10;$
 $R_f = 820\Omega$

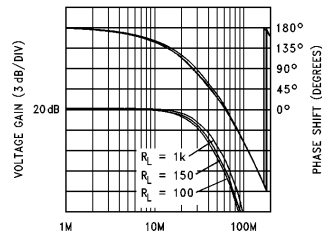

TL/H/11328-5

Typical Performance Characteristics $T_A = 25^\circ\text{C}$ unless otherwise noted (Continued)

**NON-INVERTING GAIN
FREQUENCY RESPONSE**
 $V_S = \pm 15\text{V}; A_V = +10;$
 $R_f = 820\Omega$

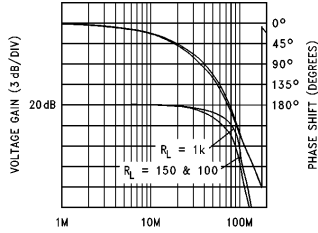

**NON-INVERTING GAIN
FREQUENCY RESPONSE**
 $V_S = \pm 5\text{V}; A_V = +10;$
 $R_f = 820\Omega$

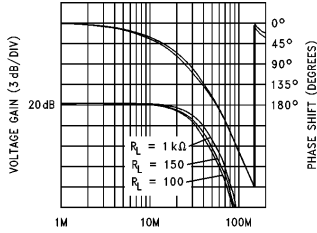

**NON-INVERTING GAIN
FREQUENCY COMPENSATION**
 $V_S = \pm 15\text{V}; A_V = +2;$
 $R_L = 150\Omega$

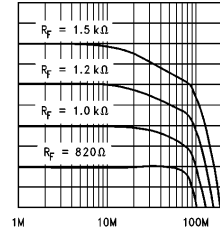

BANDWIDTH vs R_f & R_S
 $A_V = -1, R_L = 1\text{ k}\Omega$

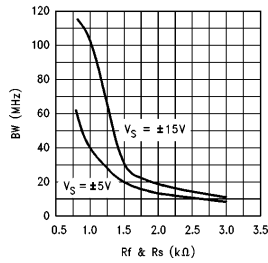

**OUTPUT SWING vs
LOAD PULSED, $V_S = \pm 15\text{V},$
 $I_{IN} = \pm 200\ \mu\text{A}, V_{IN+} = 0\text{V}$**

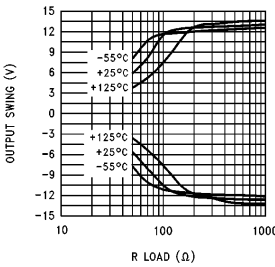

**TRANSIMPEDANCE
vs FREQUENCY**
 $V_S = \pm 15\text{V}$
 $R_L = 1\text{ k}\Omega$

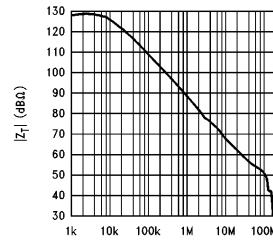

**TRANSIMPEDANCE
vs FREQUENCY**
 $V_S = \pm 15\text{V}$
 $R_L = 100\Omega$

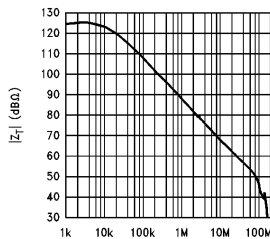

**TRANSIMPEDANCE
vs FREQUENCY**
 $V_S = \pm 5\text{V}$
 $R_L = 1\text{ k}\Omega$

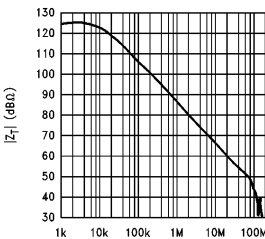

**TRANSIMPEDANCE
vs FREQUENCY**
 $V_S = \pm 5\text{V}$
 $R_L = 100\Omega$

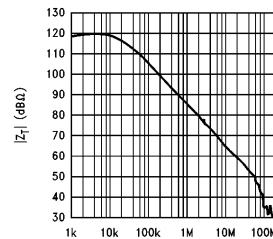

SETTLING RESPONSE
 $V_S = \pm 15\text{V}; R_L = 150\Omega;$
 $V_O = \pm 5\text{V}; A_V = -1$

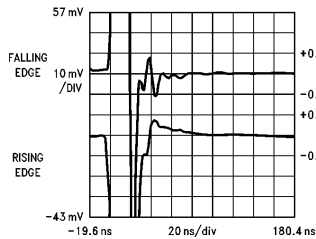

SETTLING RESPONSE
 $V_S = \pm 5\text{V}; R_L = 150\Omega;$
 $V_O = \pm 2\text{V}; A_V = -1$

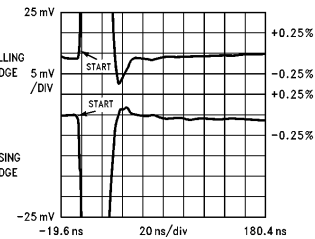

SUGGESTED R_f and R_S for C_L
 $A_V = -1; R_L = 150\Omega$

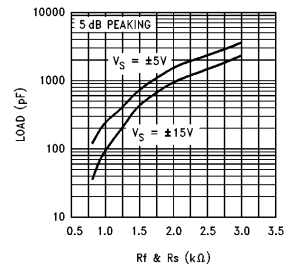

TL/H/11328-6

Typical Performance Characteristics $T_A = 25^\circ\text{C}$ unless otherwise noted (Continued)

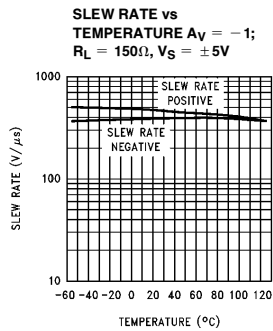
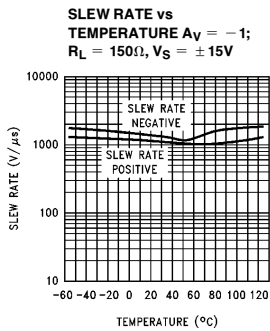
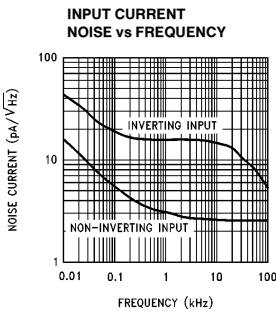
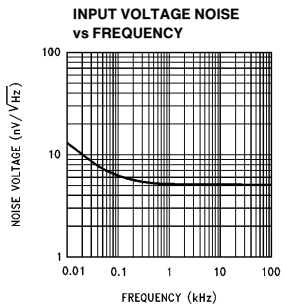
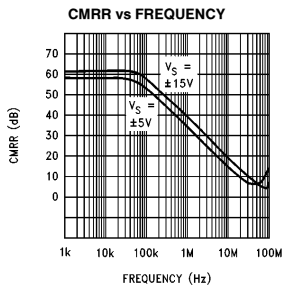
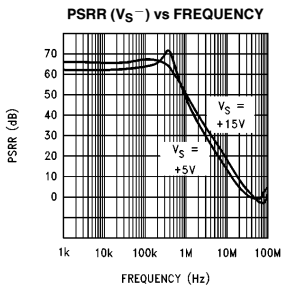
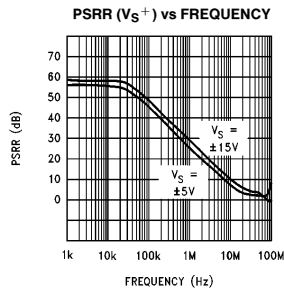
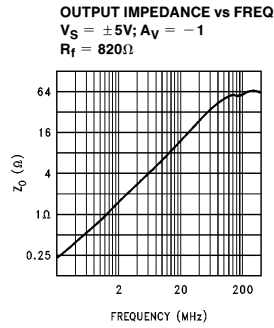
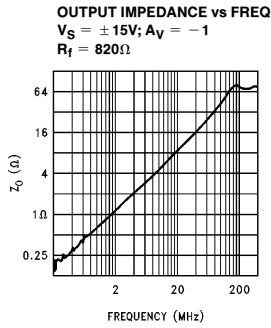
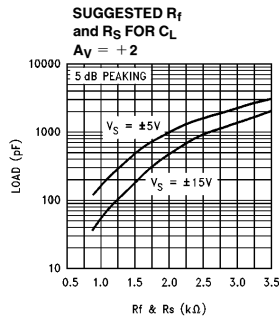
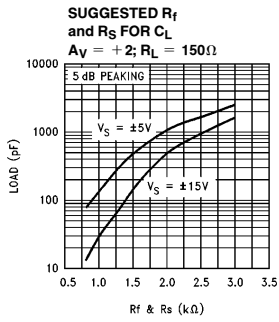
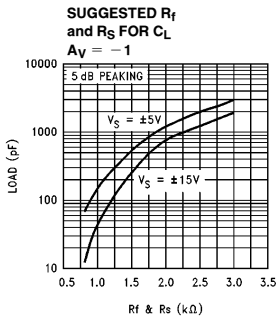

TL/H/11328-7

Typical Performance Characteristics $T_A = 25^\circ\text{C}$ unless otherwise noted (Continued)

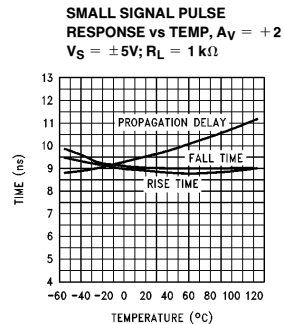
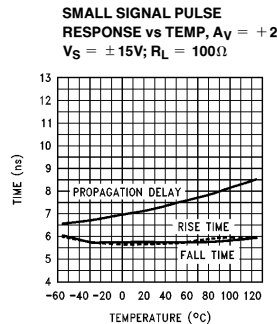
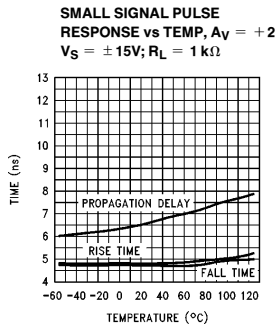
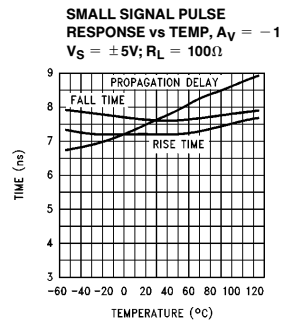
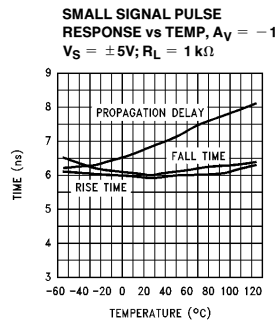
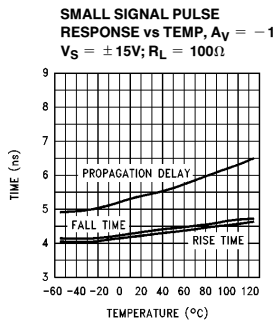
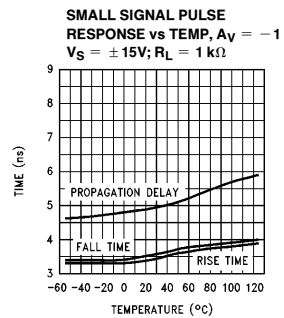
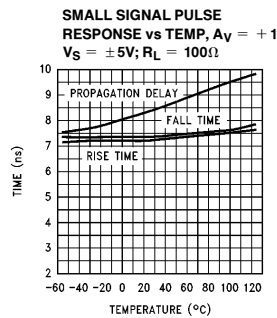
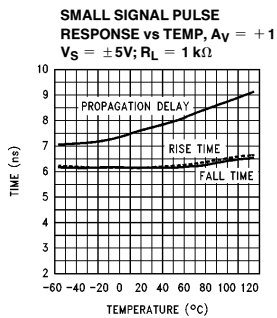
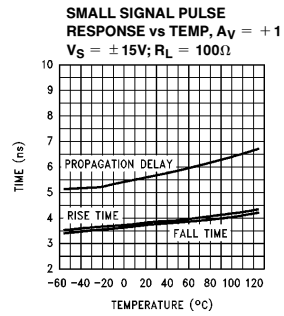
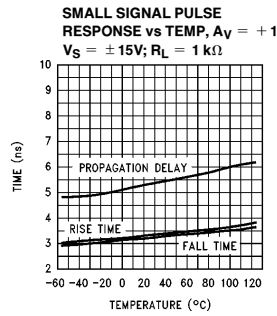
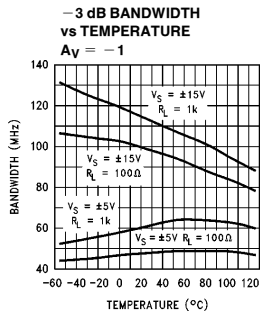

TL/H/11328-29

Typical Performance Characteristics $T_A = 25^\circ\text{C}$ unless otherwise noted (Continued)

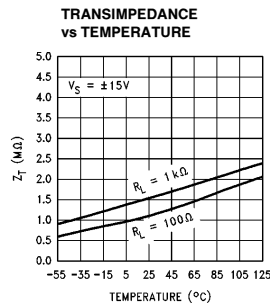
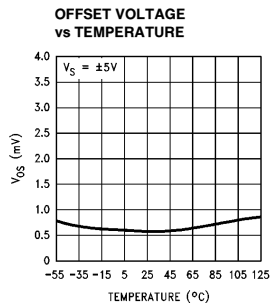
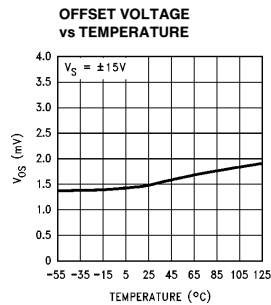
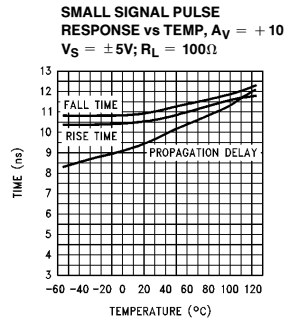
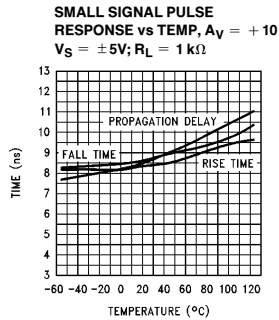
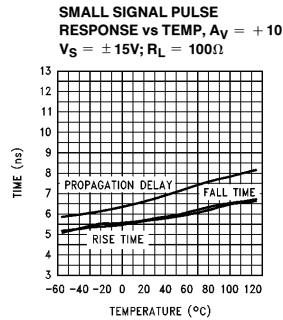
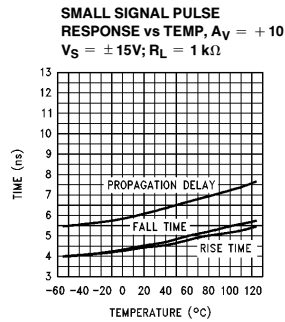
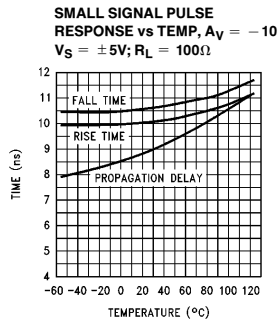
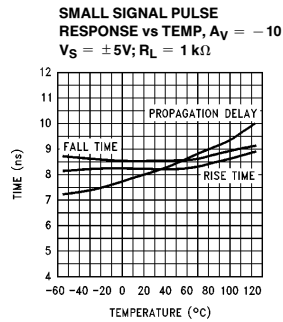
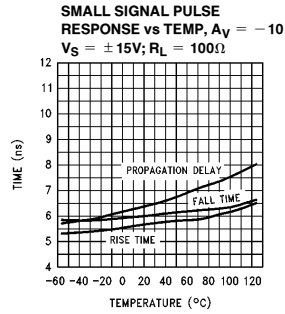
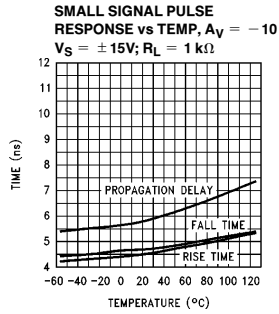
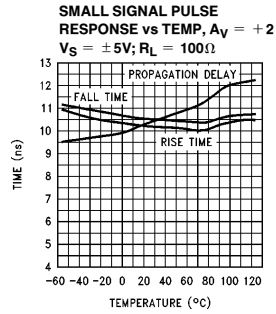

TL/H/11328-8

Typical Performance Characteristics $T_A = 25^\circ\text{C}$ unless otherwise noted (Continued)

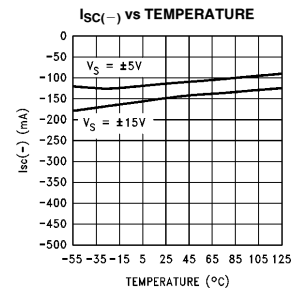
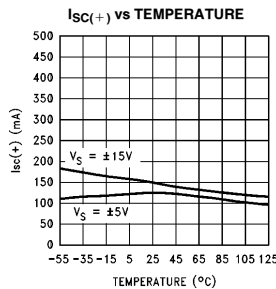
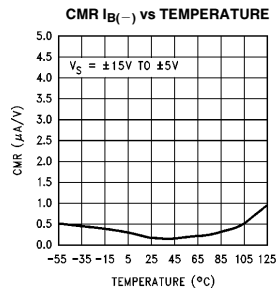
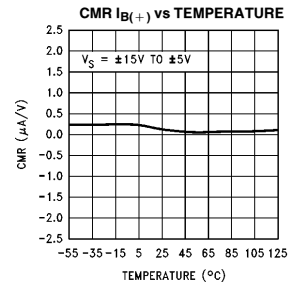
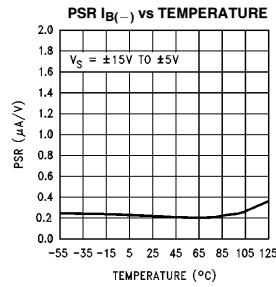
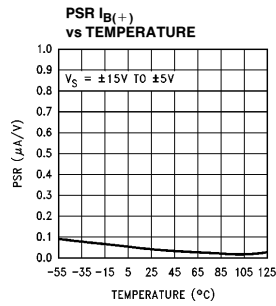
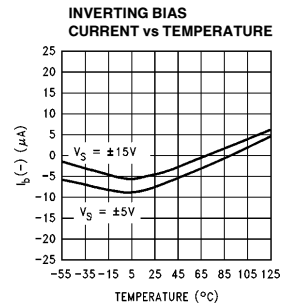
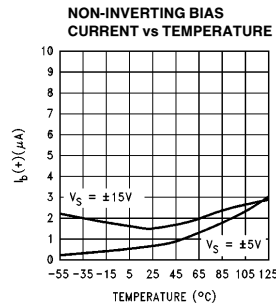
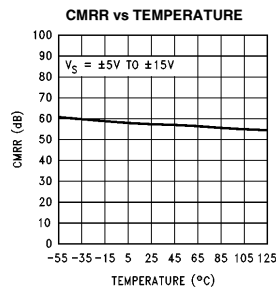
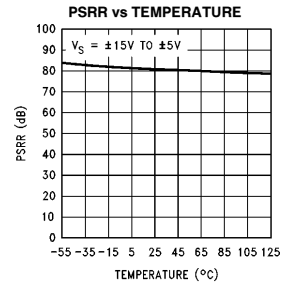
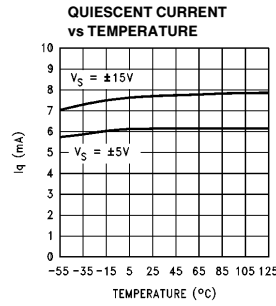
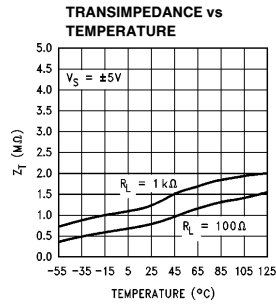

TL/H/11328-9

Typical Performance Characteristics

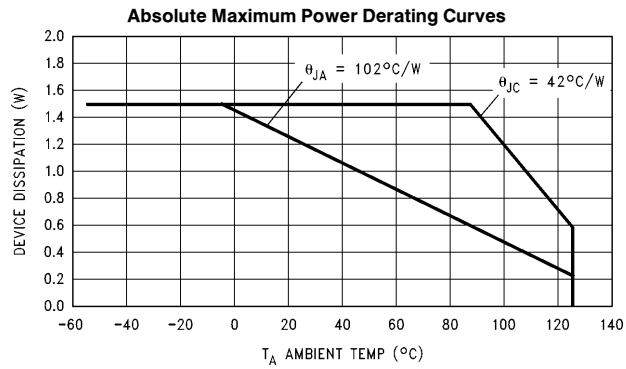

TL/H/11328-30

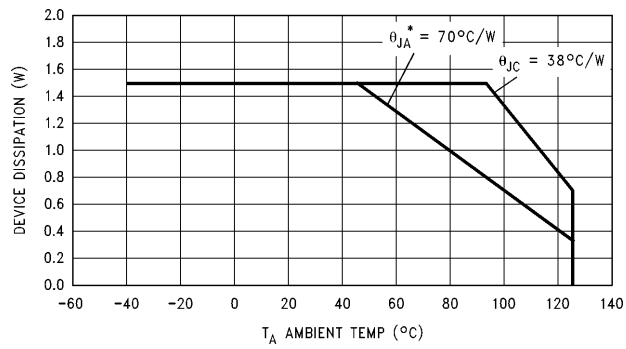

TL/H/11328-31

* θ_{JA} = Thermal Resistance with 2 square inches of 1 ounce Copper tied to Pins 1, 8, 9 and 16.

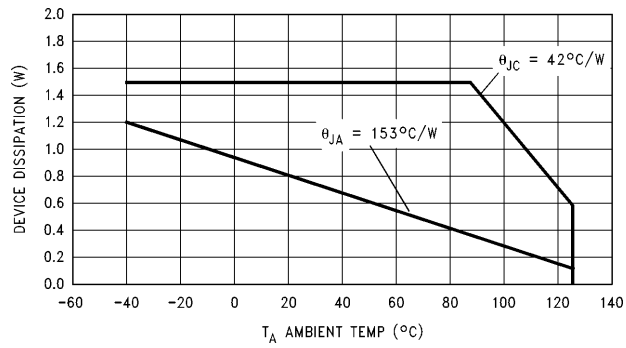

TL/H/11328-33

Typical Performance Characteristics (Continued)

Simplified Schematic

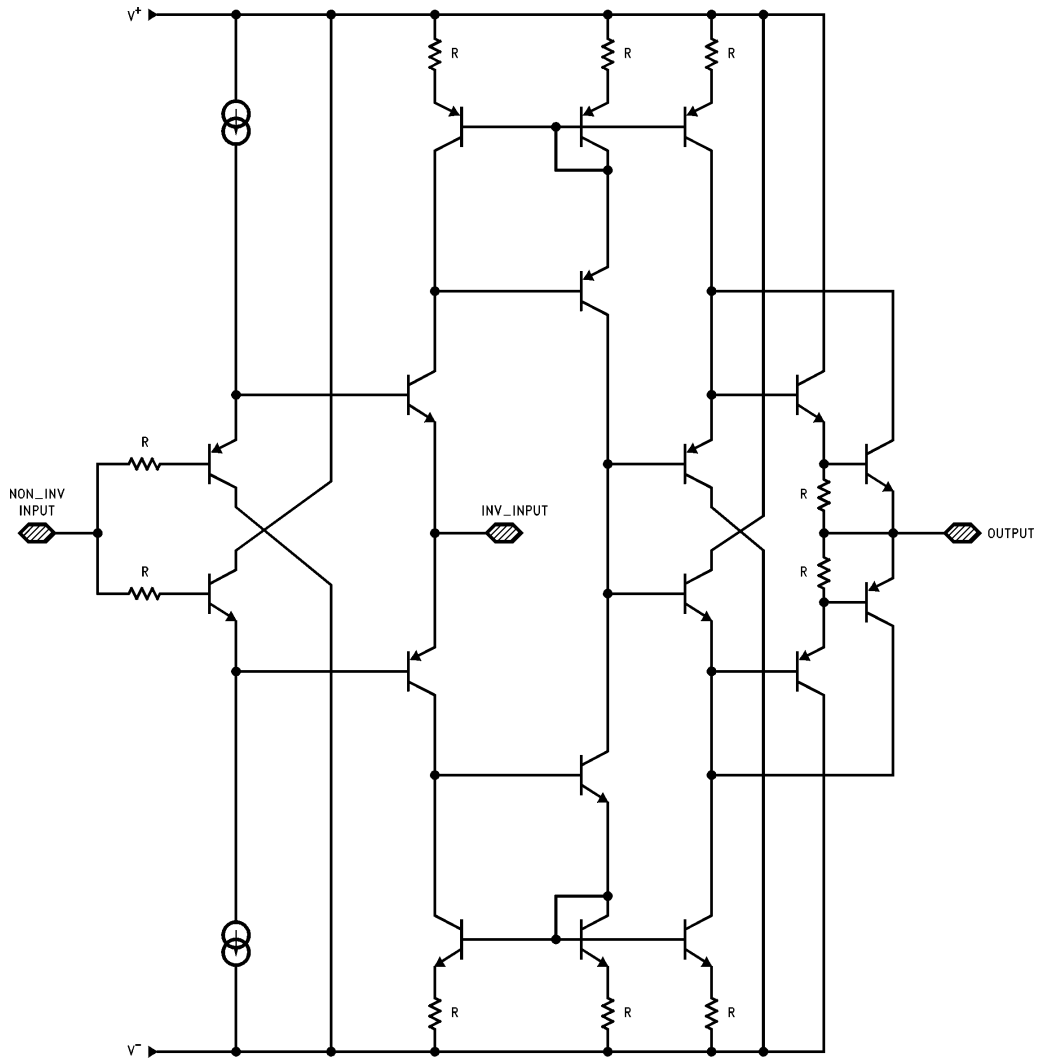

TL/H/11328-32

Typical Applications

CURRENT FEEDBACK TOPOLOGY

For a conventional voltage feedback amplifier the resulting small-signal bandwidth is inversely proportional to the desired gain to a first order approximation based on the gain-bandwidth concept. In contrast, the current feedback amplifier topology, such as the LM6181, transcends this limitation to offer a signal bandwidth that is relatively independent of the closed-loop gain. *Figures 1a* and *1b* illustrate that for closed loop gains of -1 and -5 the resulting pulse fidelity suggests quite similar bandwidths for both configurations.

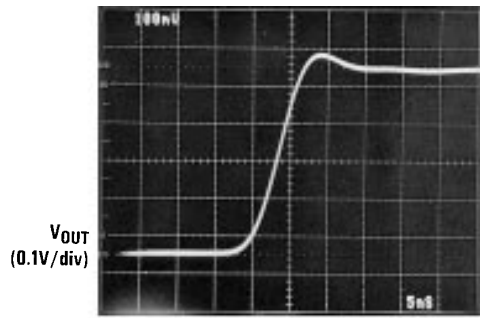

TIME (5 ns/div)

1a

TL/H/11328-12

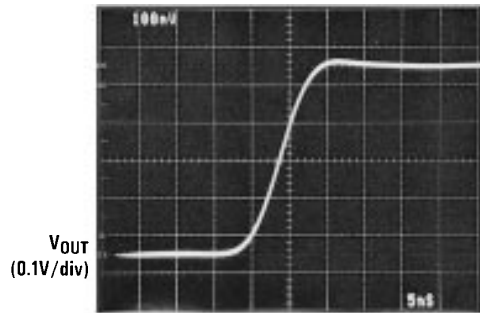

TIME (5 ns/div)

1b

TL/H/11328-13

FIGURES 1a, 1b: Variation of Closed Loop Gain from -1 to -5 Yields Similar Responses

The closed-loop bandwidth of the LM6181 depends on the feedback resistance, R_f . Therefore, R_S and not R_f , must be varied to adjust for the desired closed-loop gain as in *Figure 2*.

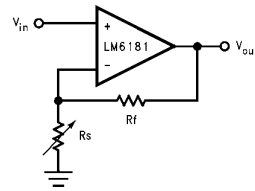

TL/H/11328-14

FIGURE 2. R_S Is Adjusted to Obtain the Desired Closed Loop Gain, A_{VCL}

POWER SUPPLY BYPASSING AND LAYOUT CONSIDERATIONS

A fundamental requirement for high-speed amplifier design is adequate bypassing of the power supply. It is critical to maintain a wideband low-impedance to ground at the amplifiers supply pins to insure the fidelity of high speed amplifier transient signals. $10\ \mu\text{F}$ tantalum and $0.1\ \mu\text{F}$ ceramic bypass capacitors are recommended for each supply pin. The bypass capacitors should be placed as close to the amplifier pins as possible ($0.5''$ or less).

FEEDBACK RESISTOR SELECTION: R_f

Selecting the feedback resistor, R_f , is a dominant factor in compensating the LM6181. For general applications the LM6181 will maintain specified performance with an $820\ \Omega$ feedback resistor. Although this value will provide good results for most applications, it may be advantageous to adjust this value slightly. Consider, for instance, the effect on pulse responses with two different configurations where both the closed-loop gains are 2 and the feedback resistors are $820\ \Omega$, and $1640\ \Omega$, respectively. *Figures 3a* and *3b* illustrate the effect of increasing R_f while maintaining the same closed-loop gain—the amplifier bandwidth decreases. Accordingly, larger feedback resistors can be used to slow down the LM6181 (see $-3\ \text{dB}$ bandwidth vs R_f typical curves) and reduce overshoot in the time domain response. Conversely, smaller feedback resistance values than $820\ \Omega$ can be used to compensate for the reduction of bandwidth at high closed loop gains, due to 2nd order effects. For example *Figure 4* illustrates reducing R_f to $500\ \Omega$ to establish the desired small signal response in an amplifier configured for a closed loop gain of 25.

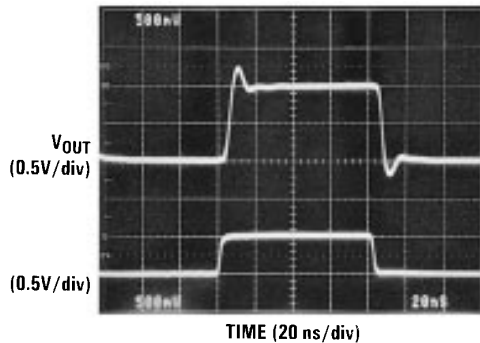

3a: $R_f = 820\ \Omega$

TL/H/11328-15

Typical Applications (Continued)

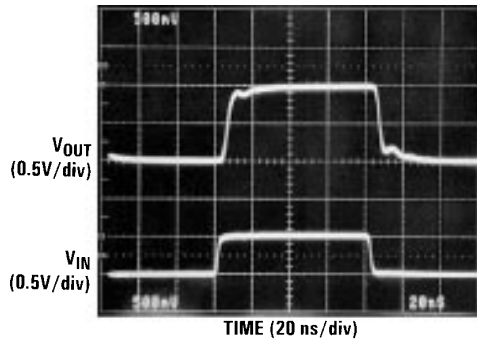

3b: $R_f = 1640\Omega$

FIGURES 3a, b: Increasing Compensation with Increasing R_f

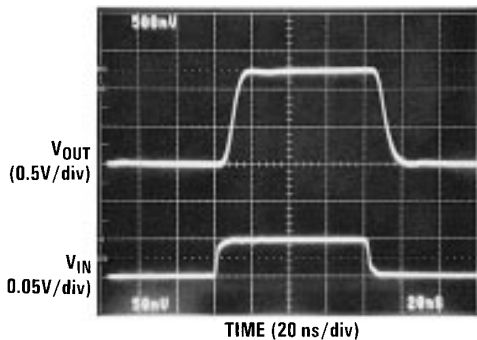

FIGURE 4: Reducing R_f for Large Closed Loop Gains, $R_f = 500\Omega$

SLEW RATE CONSIDERATIONS

The slew rate characteristics of current feedback amplifiers are different than traditional voltage feedback amplifiers. In voltage feedback amplifiers slew rate limiting or non-linear amplifier behavior is dominated by the finite availability of the 1st stage tail current charging the compensation capacitor. The slew rate of current feedback amplifiers, in contrast, is not constant. Transient current at the inverting input determines slew rate for both inverting and non-inverting gains. The non-inverting configuration slew rate is also determined by input stage limitations. Accordingly, variations of slew rates occur for different circuit topologies.

DRIVING CAPACITIVE LOADS

The LM6181 can drive significantly larger capacitive loads than many current feedback amplifiers. Although the LM6181 can directly drive as much as 100 pF without oscillating, the resulting response will be a function of the feedback resistor value. Figure 5 illustrates the small-signal pulse response of the LM6181 while driving a 50 pF load. Ringing persists for approximately 70 ns. To achieve pulse responses with less ringing either the feedback resistor can be increased (see typical curves Suggested R_f and R_s for C_L), or resistive isolation can be used (10Ω – 51Ω typically works well). Either technique, however, results in lowering the system bandwidth.

Figure 6 illustrates the improvement obtained with using a 47Ω isolation resistor.

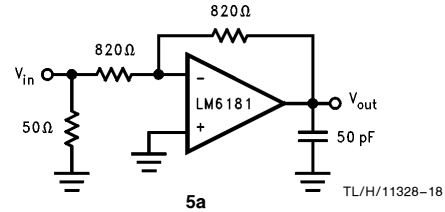

5a

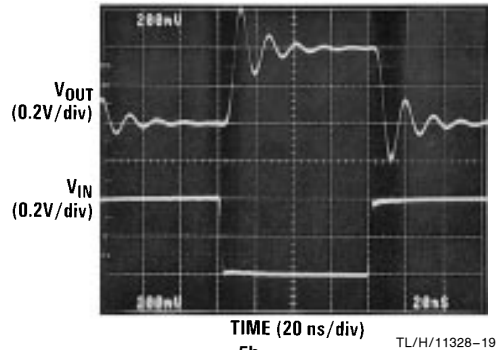

5b

FIGURES 5a, b: $A_V = -1$, LM6181 Can Directly Drive 50 pF of Load Capacitance with 70 ns of Ringing Resulting in Pulse Response

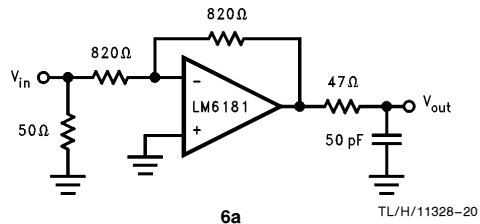

6a

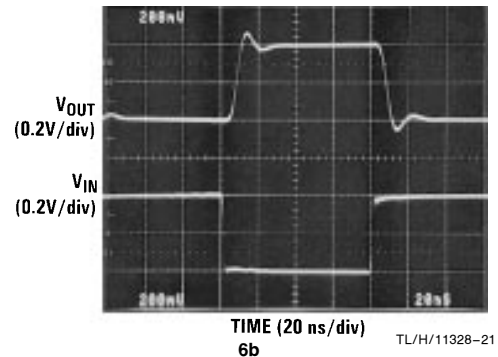

6b

FIGURES 6a, b: Resistive Isolation of C_L Provides Higher Fidelity Pulse Response. R_f and R_s Could Be Increased to Maintain $A_V = -1$ and Improve Pulse Response Characteristics.

Typical Applications (Continued)

CAPACITIVE FEEDBACK

For voltage feedback amplifiers it is quite common to place a small lead compensation capacitor in parallel with feedback resistance, R_f . This compensation serves to reduce the amplifier's peaking in the frequency domain which equivalently tames the transient response. To limit the bandwidth of current feedback amplifiers, do not use a capacitor across R_f . The dynamic impedance of capacitors in the feedback loop reduces the amplifier's stability. Instead, reduced peaking in the frequency response, and bandwidth limiting can be accomplished by adding an RC circuit, as illustrated in *Figure 7b*.

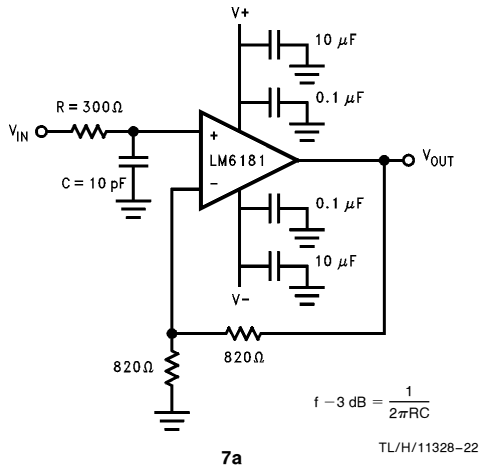

TL/H/11328-22

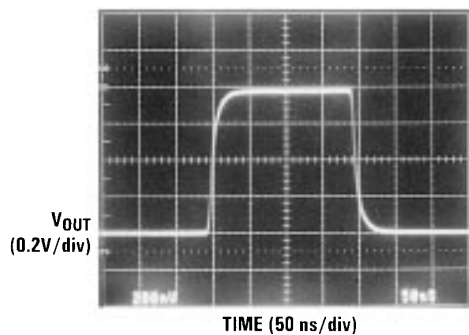

TL/H/11328-23

FIGURES 7a, b: RC Limits Amplifier Bandwidth to 50 MHz, Eliminating Peaking in the Resulting Pulse Response

Typical Performance Characteristics

OVERDRIVE RECOVERY

When the output or input voltage range of a high speed amplifier is exceeded, the amplifier must recover from an overdrive condition. The typical recovery times for open-loop, closed-loop, and input common-mode voltage range overdrive conditions are illustrated in *Figures 9, 11 and 12*, respectively.

The open-loop circuit of *Figure 8* generates an overdrive response by allowing the $\pm 0.5\text{V}$ input to exceed the linear input range of the amplifier. Typical positive and negative overdrive recovery times shown in *Figure 9* are 5 ns and 25 ns, respectively.

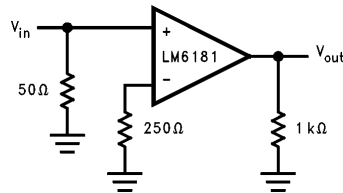

TL/H/11328-24

FIGURE 8

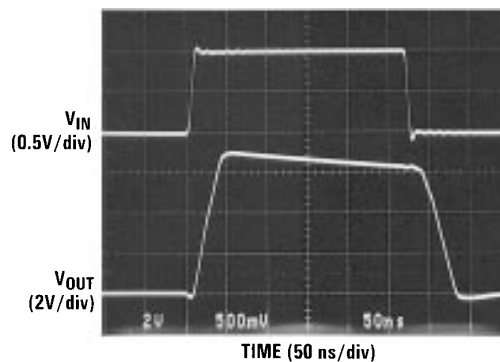

TL/H/11328-25

FIGURE 9. Open-Loop Overdrive Recovery Time of 5 ns, and 25 ns from Test Circuit in *Figure 8*

Typical Performance

Characteristics (Continued)

The large closed-loop gain configuration in *Figure 10* forces the amplifier output into overdrive. *Figure 11* displays the typical 30 ns recovery time to a linear output value.

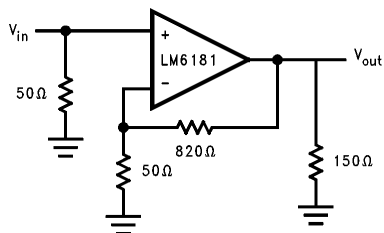

FIGURE 10

TL/H/11328-26

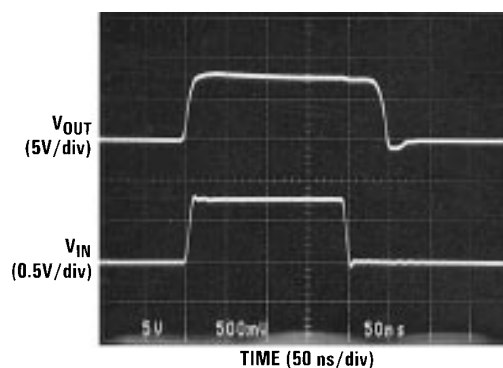

FIGURE 11. Closed-Loop Overdrive Recovery
Time of 30 ns from Exceeding Output
Voltage Range from Circuit in *Figure 10*

TL/H/11328-27

The common-mode input of the circuit in *Figure 10* is exceeded by a 5V pulse resulting in a typical recovery time of 310 ns shown in *Figure 12*. The LM6181 supply voltage is $\pm 5V$.

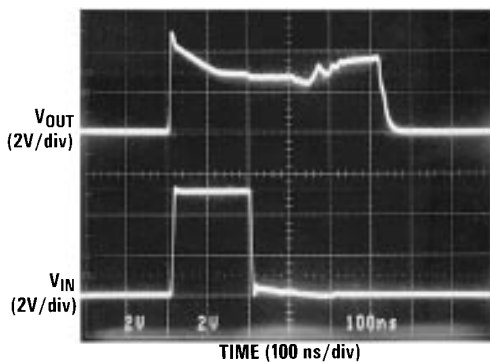

FIGURE 12. Exceptional Output
Recovery from an Input that
Exceeds the Common-Mode Range

TL/H/11328-28

Ordering Information

Package	Temperature Range		NSC Drawing
	Military -55°C to +125°C	Industrial -40°C to +85°C	
8-Pin Molded DIP	LM6181AMN	LM6181AIN LM6181IN	N08E
8-Pin Small Outline Molded Package		LM6181AIM-8 LM6181IM-8	M08A
16-Pin Small Outline		LM6181AIM LM6181IM	M16A
8-Pin Ceramic DIP	LM6181AMJ/883		J08A

Physical Dimensions inches (millimeters)

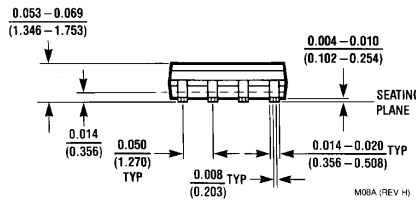
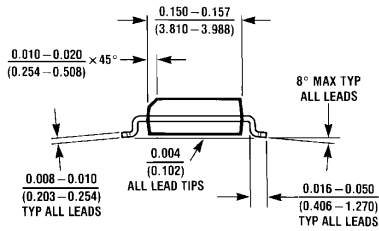
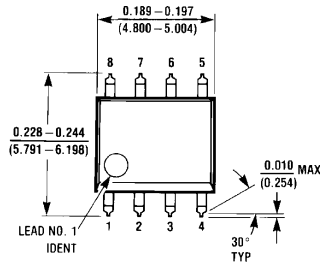

8-Lead (0.150" Wide) Small Outline Molded Package (M-8)
Order Number LM6181AIM-8 or LM6181IM-8
NS Package Number M08A

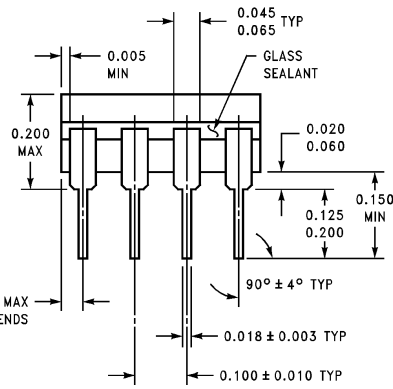
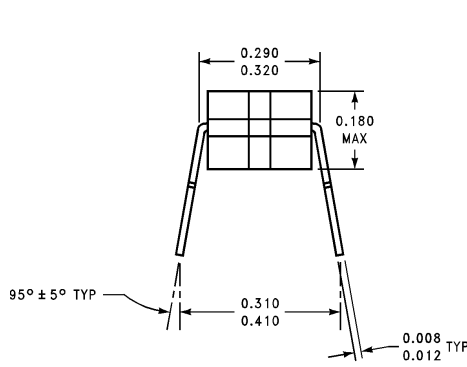
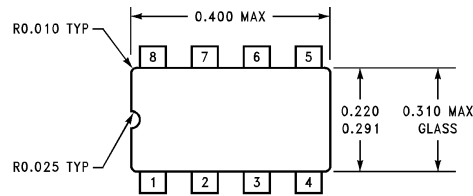

8-Pin Ceramic Dual-In-Line Package
Order Number LM6181AMJ/883
NS Package Number J08A

Physical Dimensions inches (millimeters) (Continued)

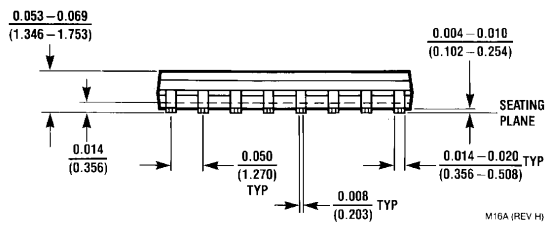
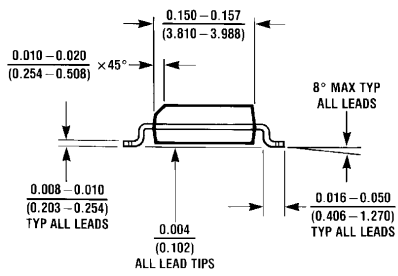
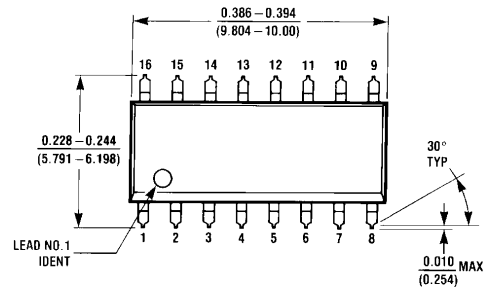

M16A (REV H)

Small Outline Package (M)
Order Number LM6181IM or LM6181AIM
NS Package Number M16A

Physical Dimensions inches (millimeters) (Continued)

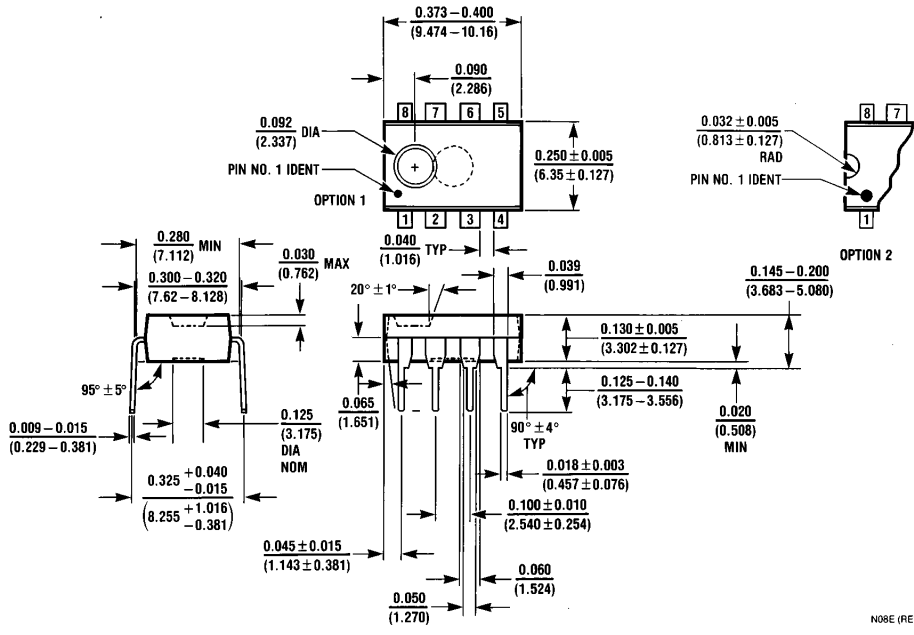

Dual-In-Line-Package (N)
Order Number LM6181AIN, LM6181IN or LM6181AMN
NS Package Number N08E

N08E (REV F)

LIFE SUPPORT POLICY

NATIONAL'S PRODUCTS ARE NOT AUTHORIZED FOR USE AS CRITICAL COMPONENTS IN LIFE SUPPORT DEVICES OR SYSTEMS WITHOUT THE EXPRESS WRITTEN APPROVAL OF THE PRESIDENT OF NATIONAL SEMICONDUCTOR CORPORATION. As used herein:

1. Life support devices or systems are devices or systems which, (a) are intended for surgical implant into the body, or (b) support or sustain life, and whose failure to perform, when properly used in accordance with instructions for use provided in the labeling, can be reasonably expected to result in a significant injury to the user.
2. A critical component is any component of a life support device or system whose failure to perform can be reasonably expected to cause the failure of the life support device or system, or to affect its safety or effectiveness.

 <p>National Semiconductor Corporation 2900 Semiconductor Drive P.O. Box 58090 Santa Clara, CA 95052-8090 Tel: (1800) 272-9959 TWX: (910) 339-9240</p>	<p>National Semiconductor GmbH Livny-Gargan-Str. 10 D-82256 Fürstenfeldbruck Germany Tel: (81-41) 35-0 Telex: 527849 Fax: (81-41) 35-1</p>	<p>National Semiconductor Japan Ltd. Sumitomo Chemical Engineering Center Bldg. 7F 1-7-1, Nakase, Mihama-Ku Chiba-City, Ciba Prefecture 261 Tel: (043) 299-2300 Fax: (043) 299-2500</p>	<p>National Semiconductor Hong Kong Ltd. 13th Floor, Straight Block, Ocean Centre, 5 Canton Rd. Tsimshatsui, Kowloon Hong Kong Tel: (852) 2737-1600 Fax: (852) 2736-9960</p>	<p>National Semicondutores Do Brazil Ltda. Rue Deputado Lacerda Franco 120-3A Sao Paulo-SP Brazil 05418-000 Tel: (55-11) 212-5066 Telex: 391-1131931 NSBR BR Fax: (55-11) 212-1181</p>	<p>National Semiconductor (Australia) Pty. Ltd. Building 16 Business Park Drive Monash Business Park Nottinghill, Melbourne Victoria 3168 Australia Tel: (3) 558-9999 Fax: (3) 558-9998</p>
---	---	---	---	--	---

National does not assume any responsibility for use of any circuitry described, no circuit patent licenses are implied and National reserves the right at any time without notice to change said circuitry and specifications.