

# Silicon Bipolar Monolithic Amplifiers

## Technical Data

**HPMA-0300**  
**HPMA-0311**  
**HPMA-0335**  
**HPMA-0370**

### Features

#### HPMA-0300

- 3 dB Bandwidth: DC to 2.8 GHz
- 12.0 dB Gain at 1 GHz
- Unconditionally Stable ( $k > 1$ )
- Cascadable 50 Ohm Gain Block

#### HPMA-0311

- 3 dB Bandwidth: DC to 2.3 GHz
- 11.6 dB Gain at 1 GHz
- Unconditionally Stable ( $k > 1$ )
- Cascadable 50 Ohm Gain Block
- Low Cost Surface Mount Plastic Package
- Tape And Reel Options Available

#### HPMA-0335/HPMA-0370

- 3 dB Bandwidth: DC to 2.8 GHz
- 12.0 dB Gain at 1 GHz
- Unconditionally Stable ( $k > 1$ )
- Cascadable 50 Ohm Gain Block
- Metal/Ceramic Microstrip Package

### Description

The HPMA-0300 is a silicon monolithic single-stage feedback amplifier chip. Series and

Chip Outline HPMA-0300

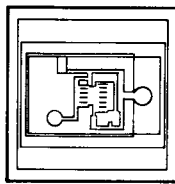

HPMA-0335

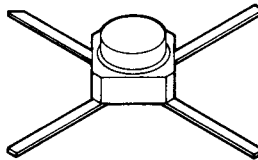

HPMA-0311

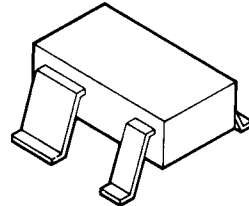

HPMA-0370

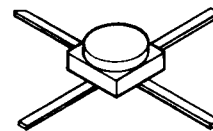

### Typical Biasing Configuration

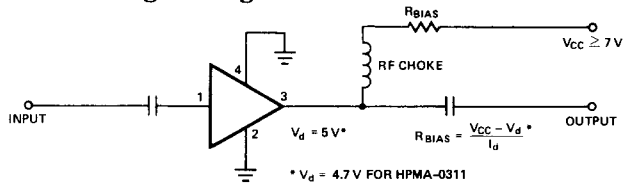

shunt feedback is used to achieve high uniformity from amplifier to amplifier. The device is ideally suited as a 50 ohm building block in narrow and broadband RF amplifier applications. Use of an optional external limiting resistor allows for biasing flexibility.

The device is manufactured using ion implantation and self-

alignment techniques and has gold metallization and nitride passivation for high reliability.

The HPMA-0300 chip is also supplied as the HPMA-0311 in the plastic surface mount SOT-143 package, and as the HPMA-0335 in the HPAC-100X and as the HPMA-0370 in the HPAC-70 rugged metal/ceramic microstrip packages.

**Ordering Information**  
 See page 16-2.

## Absolute Maximum Ratings\* ( $T_A = 25^\circ\text{C}$ )

Symbol	Parameter	Units	Value			
			HPMA-0300 <sup>(1)</sup>	HPMA-0311 <sup>(2,5)</sup>	HPMA-0335 <sup>(2,5)</sup>	HPMA-0370 <sup>(4,5)</sup>
$I_d$	Device Current	mA	80	60	80	80
$P_t$	Total Device Dissipation	mW	425	240	425	425
$P_{in}$	RF Input Power	dBm	+20	+20	+20	+20
$T_j$	Junction Temperature	$^\circ\text{C}$	200	150	200	200
$T_{stg}$	Storage Temperature	$^\circ\text{C}$	200	150	150	200

\*Operation in excess of any one of these conditions may result in permanent damage to this device.

### Notes:

1. Thermal resistance  $\theta_{j\alpha} = 50^\circ\text{C}/\text{W}$ . Derate at  $20 \text{ mW}/^\circ\text{C}$  for  $T_j > 178^\circ\text{C}$ .
2. A  $\theta_{j\alpha}$  of  $500^\circ\text{C}/\text{W}$  should be used for derating and junction temperature calculations:  $T_j = (P_d \times \theta_{j\alpha}) + T_A$ .
3. Thermal resistance  $\theta_{j\alpha} = 90^\circ\text{C}/\text{W}$ . Derate at  $11.1 \text{ mW}/^\circ\text{C}$  for  $T_j > 162^\circ\text{C}$ .
4. Thermal resistance  $\theta_{j\alpha} = 80^\circ\text{C}/\text{W}$ . Derate at  $12.5 \text{ mW}/^\circ\text{C}$  for  $T_j > 166^\circ\text{C}$ .
5. Maximum soldering temperature is  $260^\circ\text{C}$  for 5 seconds.

## Electrical Specifications ( $T_A = 25^\circ\text{C}$ )

Symbol	Parameters and Test Conditions $I_d = 35 \text{ mA}$ , $Z_o = 50 \Omega$	Units	HPMA-0300			HPMA-0311			HPMA-0335			HPMA-0370		
			Min.	Typ.	Max.	Min.	Typ.	Max.	Min.	Typ.	Max.	Min.	Typ.	Max.
G	Small Signal Gain ( $ S_{21} ^2$ ) $f = 0.1 \text{ GHz}$ $f = 0.5 \text{ GHz}$ $f = 1.0 \text{ GHz}$	dB		12.4			12.4		11.5	12.4	13.5	11.5	12.6	13.5
$\Delta G$	Gain Flatness $*f = 0.1$ to $1.6 \text{ GHz}$	dB		$\pm 0.6$			$\pm 0.7$			$\pm 0.6$	$\pm 1.0$		$\pm 0.6$	$\pm 1.0$
$F_{3 \text{ dB}}$	3 dB Bandwidth	GHz		2.8			2.3			2.7			2.8	
VSWR	Input VSWR $f = 0.1$ to $3.0 \text{ GHz}$			1.7:1			1.4:1			1.7:1			1.9:1	
	Output VSWR $f = 0.1$ to $3.0 \text{ GHz}$			1.3:1			1.5:1			1.3:1			1.6:1	
$P_{1 \text{ dB}}$	Output Power @ 1 dB Compression $f = 1.0 \text{ GHz}$	dBm		10.0			9.8			10.0			10.0	
NF	50 Ohm Noise Figure $f = 1.0 \text{ GHz}$	dB		5.3			5.5			5.3			5.3	
$IP_3$	Third Order Intercept Point $f = 1.0 \text{ GHz}$	dBm		23.0			22.0			23.0			23.0	
$t_d$	Group Delay $f = 1.0 \text{ GHz}$	psec.		125			140			125			125	
$V_d$	Device Voltage	Volts	4.5	5.0	5.5	3.8	4.7	5.6	4.5	5.0	5.5	4.5	5.0	5.5
dV/dT	Device Voltage Temperature Coefficient	mV/ $^\circ\text{C}$		-8.0			-8.0			-8.0			-8.0	

\* $f = 0.1$  to  $1.8 \text{ GHz}$  for HPMA-0300.

Note: The recommended operating current range for these devices is 20 mA to 50 mA. Typical performance as a function of current is shown of the following pages.

**Chip Outline HPM-0300**

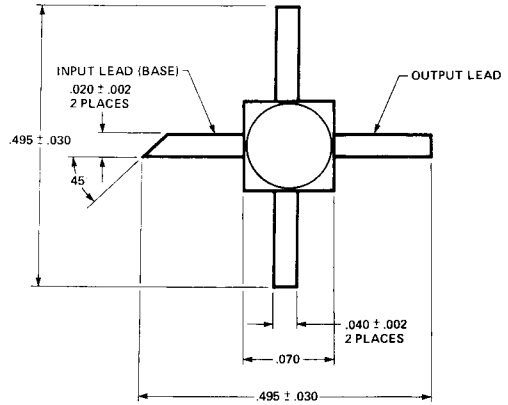
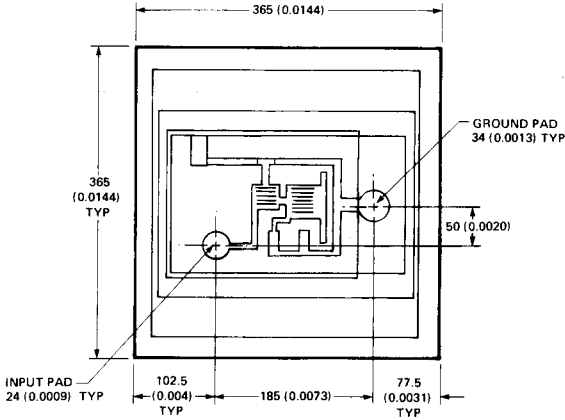

NOTE: BACK SIDE OF CHIP IS OUTPUT.  
DIMENSIONS IN MICROMETRES (INCHES) ± 25 (0.001)

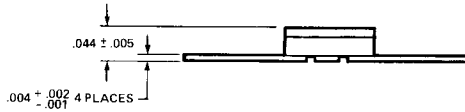

OUTLINE HPAAC-100X

**HPMA-0311 Typical S-Parameters ( $Z_0 = 50 \Omega$ ,  $T_A = 25^\circ\text{C}$ ,  $I_d = 35 \text{ mA}$ )**

Freq. (MHz)	$S_{11}$		$S_{21}$			$S_{12}$		$S_{22}$		
	Mag.	Ang.	dB	Mag.	Ang.	dB	Mag.	Ang.	Mag.	Ang.
100	0.03	168	12.4	4.17	174	-18.1	0.124	1	0.16	-9
200	0.03	158	12.4	4.18	169	-18.1	0.124	3	0.16	-16
300	0.03	147	12.4	4.15	164	-18.1	0.125	4	0.17	-22
400	0.03	133	12.3	4.13	158	-18.0	0.126	6	0.17	-34
500	0.02	115	12.2	4.06	153	-17.9	0.127	7	0.16	-39
600	0.02	92	12.1	4.04	148	-17.8	0.129	9	0.17	-47
700	0.02	90	12.0	4.00	142	-17.6	0.132	10	0.17	-52
800	0.02	33	11.9	3.92	137	-17.5	0.134	11	0.17	-59
900	0.03	10	11.8	3.88	132	-17.3	0.136	12	0.18	-64
1000	0.04	-3	11.6	3.81	127	-17.2	0.139	13	0.17	-71
1500	0.08	-56	10.8	3.48	103	-16.2	0.155	15	0.18	-89
2000	0.12	-93	9.9	3.12	80	-15.3	0.171	14	0.18	-98
2500	0.15	-120	8.8	2.75	63	-14.7	0.184	14	0.19	-104
3000	0.17	-154	7.8	2.45	45	-14.4	0.192	12	0.18	-106
3500	0.19	170	6.7	2.17	13	-14.0	0.201	10	0.21	-107
4000	0.25	140	5.6	1.91	-1	-13.6	0.208	9	0.23	-116
4500	0.33	118	4.5	1.68	-14	-13.3	0.215	8	0.25	-126
5000	0.42	101	3.4	1.48	-3	-12.8	0.228	7	0.27	-137

HPMA-0335 Typical S-Parameters ( $Z_0 = 50 \Omega$ ,  $T_A = 25^\circ\text{C}$ ,  $I_d = 35 \text{ mA}$ )

Freq. (MHz)	$S_{11}$		$S_{21}$			$S_{12}$			$S_{22}$	
	Mag.	Ang.	dB	Mag.	Ang.	dB	Mag.	Ang.	Mag.	Ang.
100	0.05	173	12.4	4.16	176	-18.2	0.123	1	0.15	-8
200	0.05	169	12.4	4.19	171	-18.2	0.123	2	0.16	-12
300	0.05	165	12.4	4.17	167	-18.1	0.124	4	0.16	-21
400	0.04	161	12.4	4.17	162	-18.1	0.125	5	0.15	-31
500	0.04	158	12.4	4.16	157	-18.0	0.126	6	0.15	-35
600	0.03	157	12.3	4.14	153	-17.9	0.128	7	0.16	-41
700	0.03	165	12.3	4.13	148	-17.8	0.129	8	0.15	-47
800	0.02	168	12.3	4.10	143	-17.7	0.131	9	0.16	-55
900	0.02	-158	12.2	4.08	139	-17.5	0.133	9	0.16	-62
1000	0.01	-141	12.1	4.04	134	-17.4	0.135	10	0.16	-69
1500	0.07	-100	11.7	3.84	111	-16.6	0.148	12	0.15	-94
2000	0.03	-118	11.0	3.55	89	-15.9	0.161	12	0.14	-112
2500	0.20	-139	10.0	3.16	72	-15.4	0.170	11	0.14	-117
3000	0.25	-159	8.9	2.79	53	-15.1	0.176	9	0.12	-121
3500	0.31	-178	7.9	2.47	37	-14.9	0.179	8	0.15	-121
4000	0.36	160	6.6	2.14	22	-14.8	0.182	7	0.18	-119
4500	0.40	152	5.5	1.88	9	-14.6	0.186	7	0.22	-126
5000	0.44	139	4.5	1.67	-3	-14.2	0.194	8	0.26	-136

HPMA-0370 Typical S-Parameters ( $Z_0 = 50 \Omega$ ,  $T_A = 25^\circ\text{C}$ ,  $I_d = 35 \text{ mA}$ )

Freq. (MHz)	$S_{11}$		$S_{21}$			$S_{12}$			$S_{22}$	
	Mag.	Ang.	dB	Mag.	Ang.	dB	Mag.	Ang.	Mag.	Ang.
100	0.06	-180	12.6	4.26	176	-18.2	0.123	1	0.15	-12
200	0.06	-177	12.5	4.24	171	-18.1	0.124	2	0.15	-19
300	0.06	-174	12.6	4.25	166	-18.1	0.124	4	0.16	-28
400	0.05	-172	12.5	4.21	162	-18.0	0.125	5	0.15	-38
500	0.05	-167	12.5	4.21	158	-18.0	0.126	6	0.16	-45
600	0.05	-161	12.4	4.17	154	-17.9	0.128	7	0.17	-53
700	0.06	-156	12.4	4.18	149	-17.8	0.130	8	0.17	-60
800	0.05	-142	12.4	4.16	145	-17.7	0.131	9	0.18	-67
900	0.05	-132	12.4	4.15	140	-17.5	0.133	10	0.17	-73
1000	0.05	-123	12.2	4.09	136	-17.4	0.135	10	0.18	-81
1500	0.11	-108	11.8	3.87	114	-16.6	0.148	13	0.20	-103
2000	0.19	-116	11.1	3.57	93	-15.9	0.161	12	0.20	-119
2500	0.25	-128	10.1	3.18	75	-15.4	0.171	12	0.19	-120
3000	0.31	-142	9.1	2.86	58	-15.1	0.176	10	0.20	-117
3500	0.35	-156	7.9	2.47	43	-15.0	0.177	8	0.22	-115
4000	0.37	-169	6.8	2.18	30	-14.9	0.180	7	0.26	-116
4500	0.39	179	5.7	1.92	18	-14.9	0.181	8	0.32	-119
5000	0.40	167	4.6	1.69	7	-14.8	0.183	8	0.36	-122

HPMA-0311 Typical Performance Parameters at  $T_A = 25^\circ\text{C}$ 

Frequency (MHz)	Linear Phase Deviation (Deg.)	Relative Phase (Deg.)	Gain Deviation (dB)	Group Delay (ns)	Input VSWR	Output VSWR
100	-2.0	0	0	0.14	1.1	1.4
200	-1.8	-5.1	-0.01	0.14	1.1	1.4
300	-1.0	-10.9	-0.04	0.16	1.1	1.4
400	-0.8	-16.0	-0.09	0.14	1.1	1.4
500	-0.2	-21.6	-0.24	0.15	1.1	1.4
600	0.0	-26.4	-0.29	0.14	1.1	1.4
700	0.6	-32.3	-0.38	0.15	1.1	1.4
800	0.6	-37.2	-0.54	0.14	1.1	1.4
900	1.1	-42.7	-0.64	0.15	1.1	1.4
1000	0.9	-47.4	-0.79	0.13	1.1	1.4
1500	0.6	-71.9	-1.58	0.13	1.2	1.5
2000	-1.7	-94.4	-2.54	0.13	1.3	1.4
2500	-9.5	-11.3	-3.61	0.12	1.3	1.5
3000	-16.3	-129.2	-4.61	0.10	1.4	1.5
3500	-24.6	-145.7	-5.67	0.09	1.5	1.5
4000	-34.0	-161.0	-6.80	0.09	1.7	1.6
4500	-44.8	-174.9	-7.88	0.08	2.0	1.7
5000	-56.4	-188.1	-8.98	0.07	2.5	1.7

HPMA-0335 Typical Performance Parameters at  $T_A = 25^\circ\text{C}$ 

Frequency (MHz)	Linear Phase Deviation (Deg.)	Relative Phase (Deg.)	Gain Deviation (dB)	Group Delay (ns)	Input VSWR	Output VSWR
100	-0.4	0	0	0.13	1.1	1.4
200	-0.3	-4.7	-0.01	0.13	1.1	1.4
300	-0.3	-9.4	-0.04	0.13	1.1	1.4
400	-0.1	-14.2	-0.03	0.13	1.1	1.4
500	-0.2	-18.7	-0.07	0.13	1.1	1.4
600	-0.1	-23.6	-0.09	0.13	1.1	1.4
700	-0.1	-28.1	-0.13	0.13	1.1	1.4
800	0	-32.8	-0.18	0.13	1.1	1.4
900	0.5	-37.9	-0.24	0.14	1.1	1.4
1000	0.5	-42.5	-0.32	0.13	1.1	1.4
1500	0.2	-65.4	-0.80	0.13	1.2	1.4
2000	-0.7	-87.8	-1.50	0.13	1.3	1.4
2500	-5.4	-105.9	-2.54	0.12	1.5	1.4
3000	-10.0	-124.5	-3.58	0.10	1.7	1.3
3500	-21.7	-140.9	-4.75	0.09	1.9	1.3
4000	-24.9	-155.8	-5.99	0.08	2.1	1.4
4500	-34.9	-168.8	-7.12	0.07	2.4	1.6
5000	-46.2	-180.7	-8.19	0.07	2.7	1.7

**HPMA-0370 Typical Performance Parameters at  $T_A = 25^\circ\text{C}$**

<b>Frequency (MHz)</b>	<b>Linear Phase Deviation (Deg.)</b>	<b>Relative Phase (Deg.)</b>	<b>Gain Deviation (dB)</b>	<b>Group Delay (ns)</b>	<b>Input VSWR</b>	<b>Output VSWR</b>
100	-0.5	0	0	0.13	1.1	1.3
200	-0.3	-4.6	-0.04	0.13	1.1	1.3
300	0.2	-9.5	-0.02	0.14	1.1	1.4
400	-0.2	-13.5	-0.09	0.11	1.1	1.4
500	0.1	-18.1	-0.09	0.13	1.1	1.4
600	-0.1	-22.3	-0.17	0.12	1.1	1.4
700	-0.3	-26.4	-0.16	0.12	1.1	1.4
800	-0.1	-31.0	-0.20	0.13	1.1	1.4
900	0.3	-35.8	-0.22	0.13	1.1	1.4
1000	0.1	-39.9	-0.35	0.12	1.1	1.4
1500	0.1	-61.8	-0.83	0.11	1.3	1.5
2000	-0.4	-83.1	-1.53	0.12	1.5	1.5
2500	-4.9	-11.4	-2.53	0.11	1.7	1.5
3000	-9.3	-117.9	-3.45	0.10	1.9	1.6
3500	-16.0	-133.0	-4.71	0.08	2.1	1.7
4000	-24.6	-146.3	-5.83	0.07	2.2	1.9
4500	-34.4	-158.3	-6.93	0.07	2.3	2.2
5000	-45.4	-169.1	-8.02	0.06	2.3	1.7

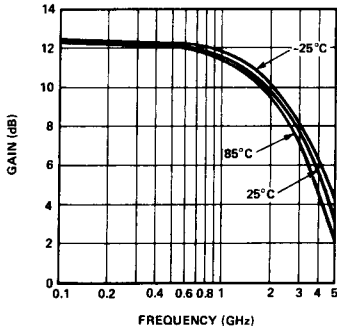

**Figure 1. Typical Small Signal Gain vs. Frequency at Three Temperatures for the HPMA-0311.**

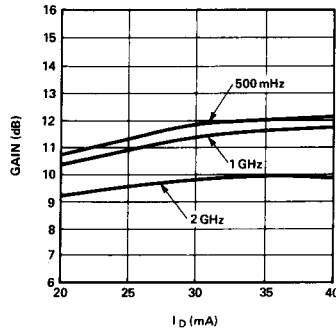

**Figure 2. Typical Small Signal Gain vs.  $I_D$  at 25°C for the HPMA-0311.**

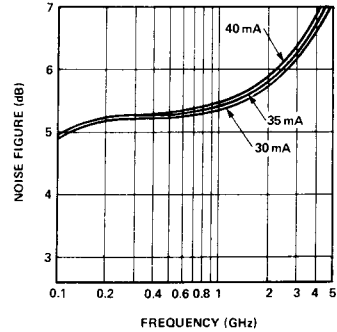

**Figure 3. Typical Noise Figure vs. Frequency at 25°C for the HPMA-0311.**

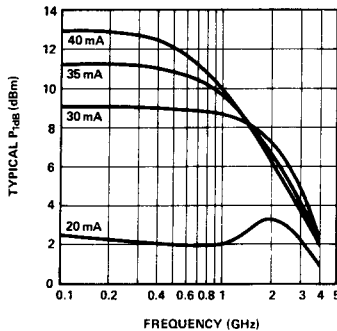

**Figure 4. Typical  $P_{1dB}$  vs. Frequency at 25°C for the HPMA-0311**

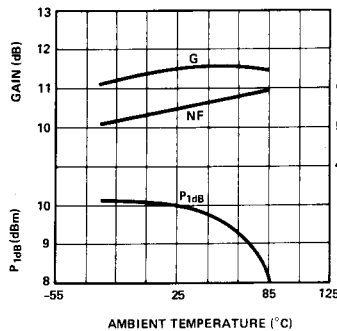

**Figure 5. Small Signal Gain, Noise Figure and  $P_{1dB}$  vs. Temperature at 1 GHz and  $I_D = 35$  mA for the HPMA-0311.**

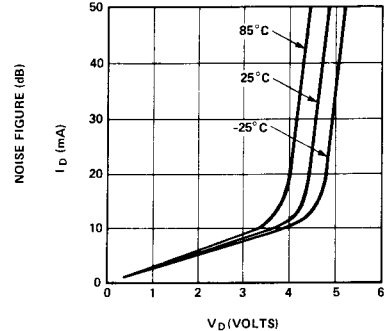

**Figure 6.  $I_D$  vs.  $V_D$  at Three Temperatures for the HPMA-0311.**

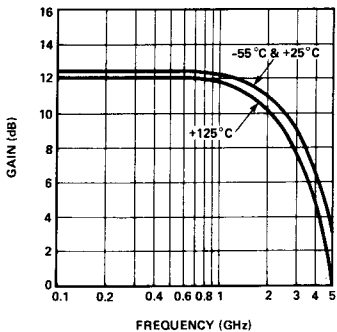

**Figure 7. Typical Small Signal Gain vs. Frequency at Three Temperatures for the HPMA-0335.**

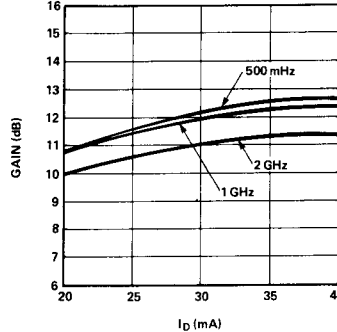

**Figure 8. Typical Small Signal Gain vs.  $I_D$  at 25°C for the HPMA-0335.**

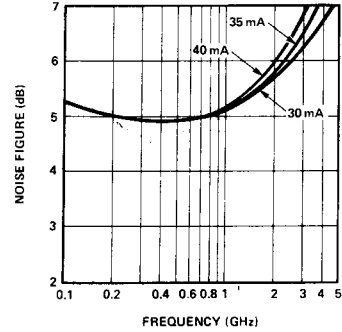

**Figure 9. Typical Noise Figure vs. Frequency at 25°C for the HPMA-0335.**

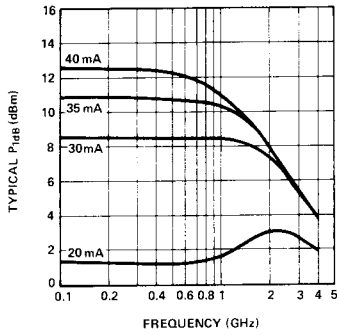

Figure 10. Typical  $P_{1dB}$  vs. Frequency at 25°C for the HPMA-0335.

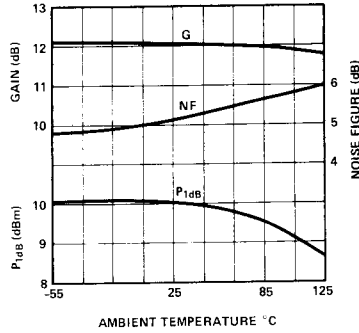

Figure 11. Small Signal Gain, Noise Figure and  $P_{1dB}$  vs. Temperature at 1 GHz and  $I_d = 35$  mA for the HPMA-0335.

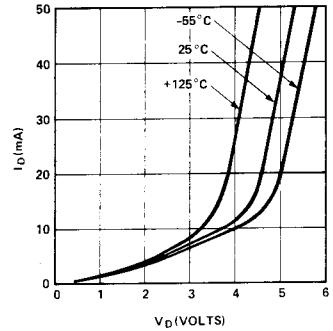

Figure 12.  $I_d$  vs.  $V_d$  at Three Temperatures for the HPMA-0335.

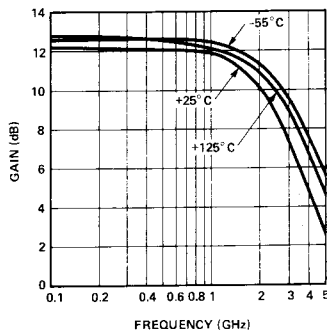

Figure 13. Typical Small Signal Gain vs. Frequency at Three Temperatures for the HPMA-0370.

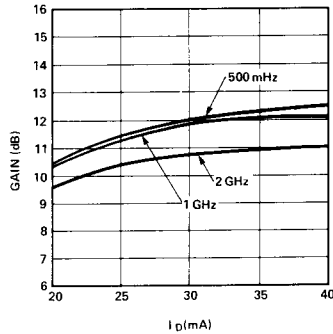

Figure 14. Typical Small Signal Gain vs.  $I_d$  at 25°C for the HPMA-0370.

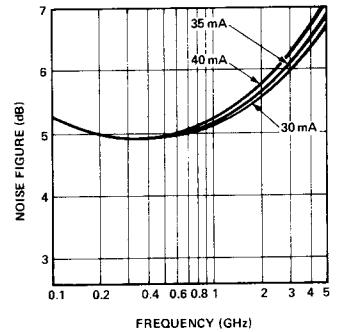

Figure 15. Typical Noise Figure vs. Frequency at 25°C for the HPMA-0370.

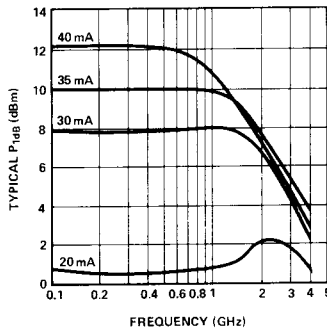

Figure 16. Typical  $P_{1dB}$  vs. Frequency at 25°C for the HPMA-0370.

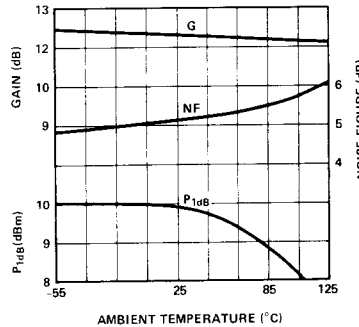

Figure 17. Small Signal Gain, Noise Figure and  $P_{1dB}$  vs. Temperature at 1 GHz and  $I_d = 35$  mA for the HPMA-0370.

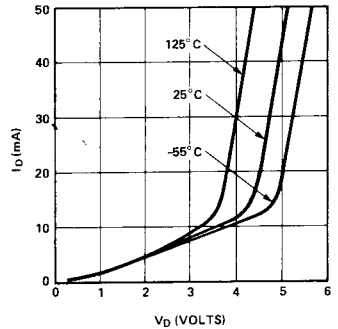

Figure 18.  $I_d$  vs.  $V_d$  at Three Temperatures for the HPMA-0370.