

MC1590G

WIDEBAND AMPLIFIER WITH AGC
SILICON MONOLITHIC INTEGRATED CIRCUIT

RF/IF/AUDIO AMPLIFIER

... an integrated circuit featuring wide-range AGC for use in RF/IF amplifiers and audio amplifiers over the temperature range, -55 to +125°C.

- High Power Gain — 50 dB Typ at 10 MHz
 45 dB Typ at 60 MHz
 35 dB Typ at 100 MHz
- Wide-Range AGC — 60 dB min, dc to 60 MHz
- Low Reverse Transfer Admittance — <10 μmhos Typ at 60 MHz
- 6.0 to 15-Volt Operation, Single-Polarity Power Supply

PIN CONNECTIONS

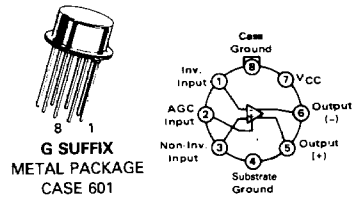

MAXIMUM RATINGS (T_A = +25°C unless otherwise noted)

Rating	Symbol*	Value	Unit
Power Supply Voltage	V _{CC}	+18	Vdc
Output Supply	V _O	+18	Vdc
AGC Supply	V ₂ (AGC)	V _{CC}	Vdc
Differential Input Voltage	V _I	5.0	Vdc
Operating Temperature Range	T _A	-55 to +125	°C
Storage Temperature Range	T _{stg}	-65 to +150	°C
Junction Temperature	T _J	+175	°C

ADMITTANCE PARAMETERS (V_{CC} = +12 Vdc, T_A = +25°C)

Parameter	Symbol	f = MHz Typ		Unit
		30	60	
Single-Ended Input Admittance	g ₁₁	0.4	0.6	mmhos
	b ₁₁	1.2	-3.0	
Single-Ended Output Admittance	g ₂₂	0.05	0.1	mmhos
	b ₂₂	0.5	1.0	
Forward Transfer Admittance (Pin 1 to Pin 5)	Y ₂₁	175	150	mmhos
	θ ₂₁ (Polar)	-30	-105	
Reverse Transfer Admittance*	g ₁₂	-0	-0	μmhos
	b ₁₂	-5.0	-10	

*The value of Reverse Transfer Admittance includes the feedback admittance of the test circuit used in the measurement. The total feedback capacitance (including test circuit) is 0.025 pF and is a more practical value for design calculations than the internal feedback of the device alone. (See Figure 10.)

REPRESENTATIVE CIRCUIT SCHEMATIC

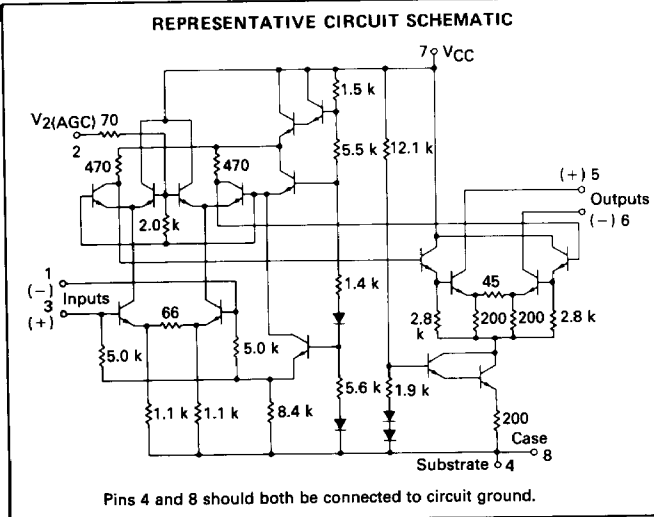

SCATTERING PARAMETERS (V_{CC} = +12 Vdc, T_A = +25°C, Z₀ = 50 Ω)

Parameter	Symbol	f = MHz Typ		Unit
		30	60	
Input Reflection Coefficient	S ₁₁	0.95	0.93	—
	θ ₁₁	-7.3	-16	
Output Reflection Coefficient	S ₂₂	0.99	0.98	—
	θ ₂₂	-3.0	-5.5	
Forward Transmission Coefficient	S ₂₁	16.8	14.7	—
	θ ₂₁	128	64.3	
Reverse Transmission Coefficient	S ₁₂	0.00048	0.00092	—
	θ ₁₂	84.9	79.2	

MC1590G

ELECTRICAL CHARACTERISTICS ($V_{CC} = +12$ Vdc, $f = 60$ MHz, BW = 1.0 MHz, $T_A = -55^\circ\text{C}$ to $+125^\circ\text{C}$ unless otherwise noted)

Characteristic	Fig.	Symbol	Min	Typ	Max	Unit
AGC Range ($V_2(\text{AGC}) = 5.0$ V to 7.0 V) ($V_2(\text{AGC}) = 5.0$ V to 7.0 V, $T_A = 25^\circ\text{C}$)	24	M_{AGC}	58 60	— 88	— —	dB
Single-Ended Power Gain ($T_A = 25^\circ\text{C}$)	24	G_p	37 40	— 45	— —	dB
Noise Figure (R_S optimized for best NF) ($T_A = 25^\circ\text{C}$)	24	NF	—	6.0	7.0	dB
Output Stage Current (Sum of Pins 5 and 6) ($T_A = 25^\circ\text{C}$)	32	I_O	3.5 4.0	— 5.6	8.0 7.5	mA
Output Current Matching (Magnitude of Difference of Output Currents) ($I_5 - I_6$) ($T_A = 25^\circ\text{C}$)	32	ΔI_O	—	0.7	—	mA
Power Supply Current ($V_O = 0$ V) ($V_O = 0$ V, $T_A = 25^\circ\text{C}$)	32	I_{CC}	— —	— 14	20 17	mA
Power Consumption ($12 \times I_{CC}$) ($V_I = 0$ V) ($V_I = 0$ V, $T_A = 25^\circ\text{C}$)	—	P_C	— —	— 168	240 204	mW

2

FIGURE 1 – UNNEUTRALIZED POWER GAIN versus FREQUENCY
(Tuned Amplifier, See Figure 24)

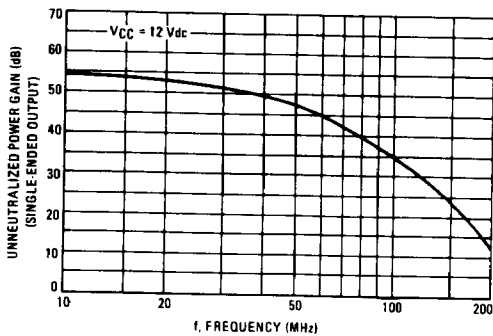
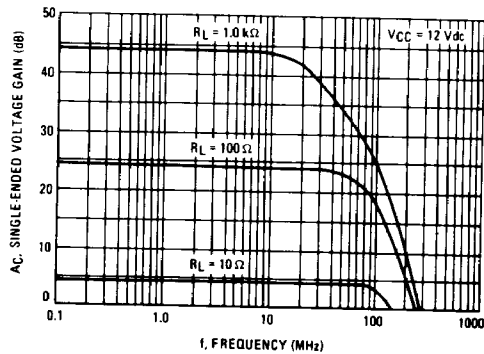

FIGURE 2 – VOLTAGE GAIN versus FREQUENCY
(Video Amplifier, See Figure 26)



MC1590G

TYPICAL CHARACTERISTICS

($V_2(AGC) = 0$, $V_{CC} = 12$ Vdc, $T_A = +25^\circ\text{C}$ unless otherwise noted)

FIGURE 3 – DYNAMIC RANGE: OUTPUT VOLTAGE versus INPUT VOLTAGE (Video Amplifier, See Figure 26)

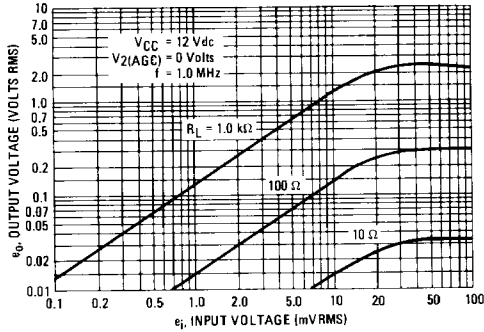

FIGURE 4 – VOLTAGE GAIN versus FREQUENCY (Video Amplifier, See Figure 26)

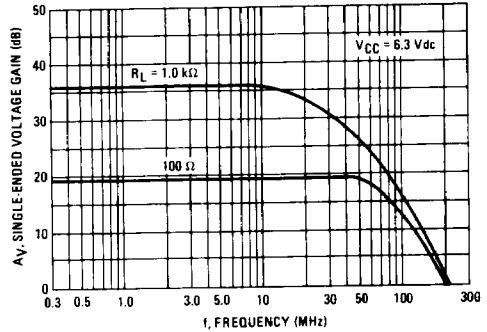

FIGURE 5 – VOLTAGE GAIN AND SUPPLY CURRENT versus SUPPLY VOLTAGE (Video Amplifier, See Figure 26)

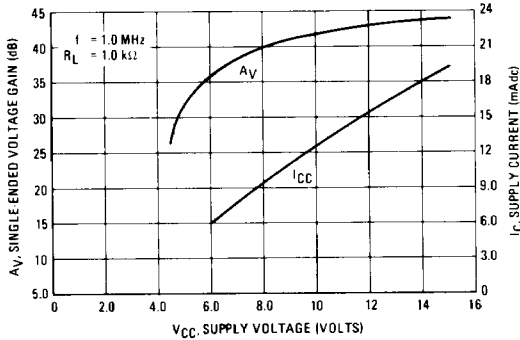

FIGURE 6 – TYPICAL GAIN REDUCTION versus AGC VOLTAGE

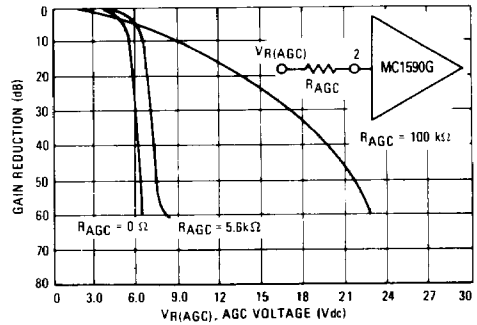

FIGURE 7 – TYPICAL GAIN REDUCTION versus AGC CURRENT

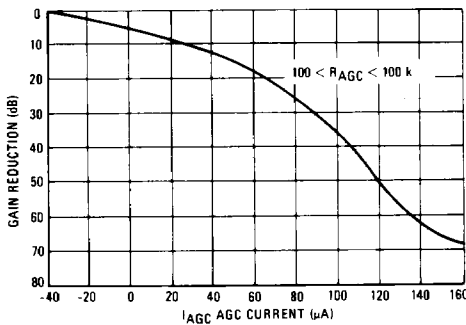
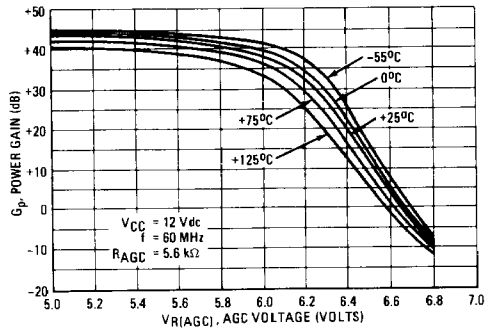

FIGURE 8 – FIXED TUNED POWER GAIN REDUCTION versus TEMPERATURE (See Test Circuit, Figure 24)



TYPICAL CHARACTERISTICS (continued)

FIGURE 9 – POWER GAIN versus SUPPLY VOLTAGE
(See Test Circuit, Figure 24)

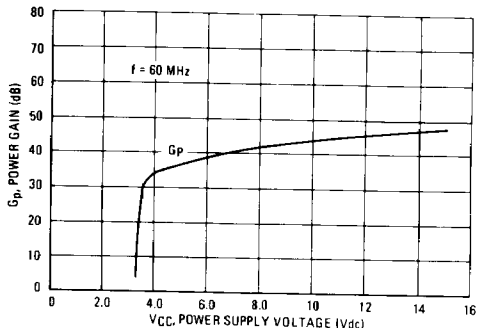

FIGURE 10 – REVERSE TRANSFER ADMITTANCE versus FREQUENCY
(See Parameter Table, Page 1)

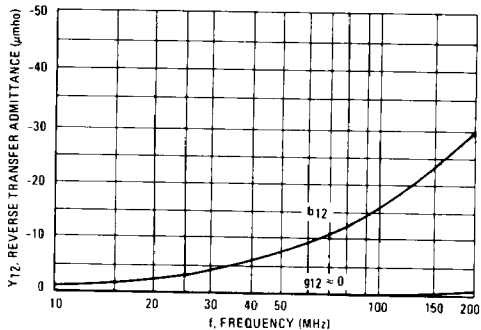

FIGURE 11 – NOISE FIGURE versus FREQUENCY

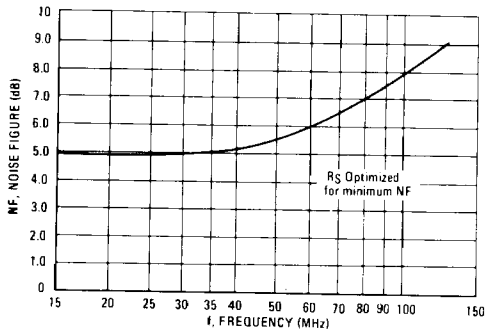

FIGURE 12 – NOISE FIGURE versus SOURCE RESISTANCE

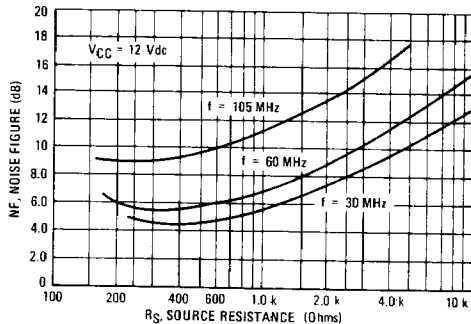
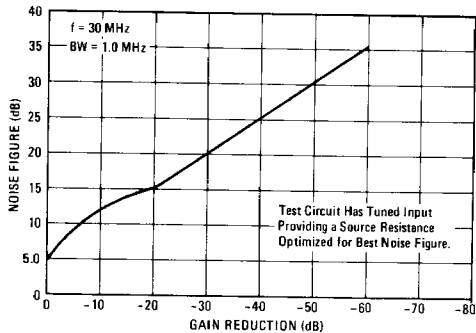

FIGURE 13 – NOISE FIGURE versus AGC GAIN REDUCTION



MC1590G

TYPICAL CHARACTERISTICS (continued)

FIGURE 14 — SINGLE-ENDED OUTPUT ADMITTANCE

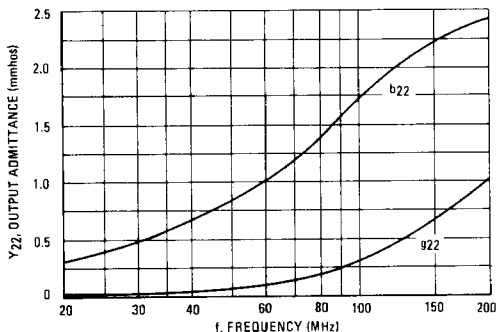

FIGURE 15 — SINGLE-ENDED INPUT ADMITTANCE

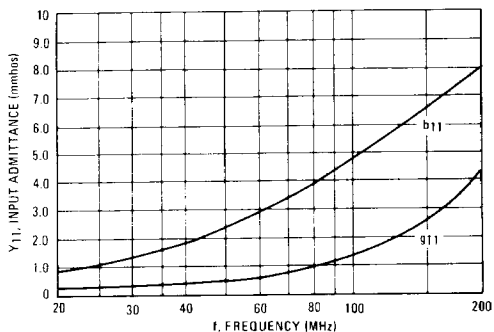

FIGURE 16 — HARMONIC DISTORTION versus AGC GAIN REDUCTION FOR AM CARRIER (For Test Circuit, See Figure 17)

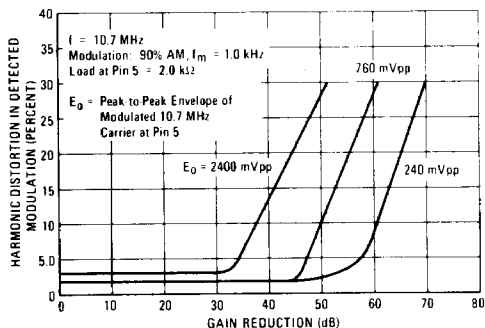

FIGURE 17 — 10.7 MHz AMPLIFIER

Gain = 55 dB, BW = 100 kHz

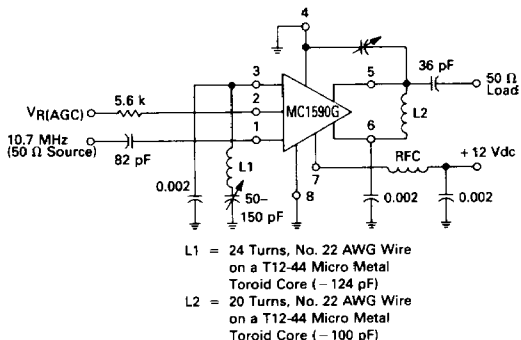

FIGURE 18 — Y_{21} , FORWARD TRANSFER ADMITTANCE RECTANGULAR FORM

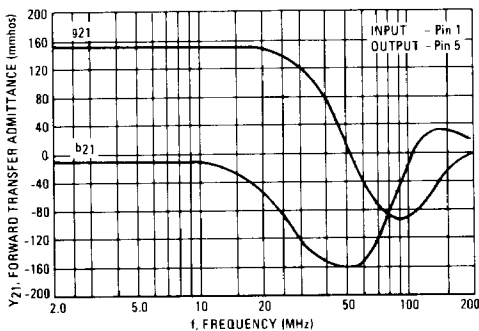
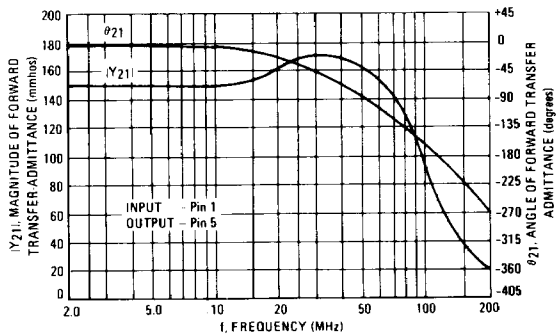

FIGURE 19 — Y_{21} , FORWARD TRANSFER ADMITTANCE POLAR FORM



TYPICAL CHARACTERISTICS (continued)

FIGURE 20 – S_{11} AND S_{22} , INPUT AND OUTPUT REFLECTION COEFFICIENT

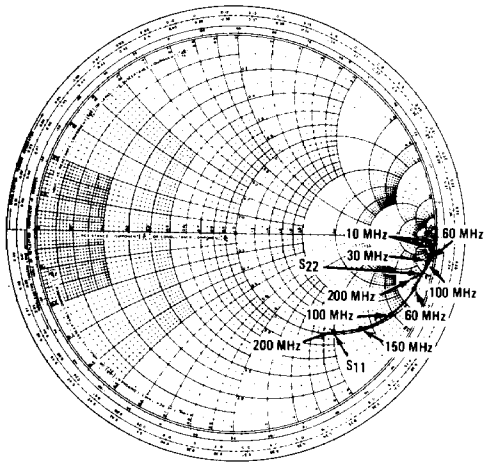

FIGURE 21 – S_{11} AND S_{22} , INPUT AND OUTPUT REFLECTION COEFFICIENT

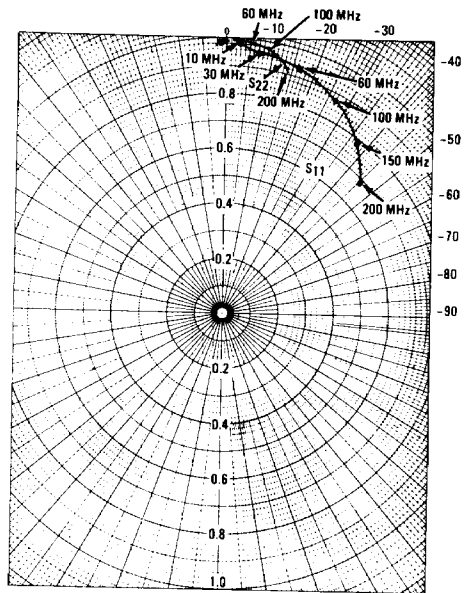

FIGURE 22 – S_{21} , FORWARD TRANSMISSION COEFFICIENT (GAIN)

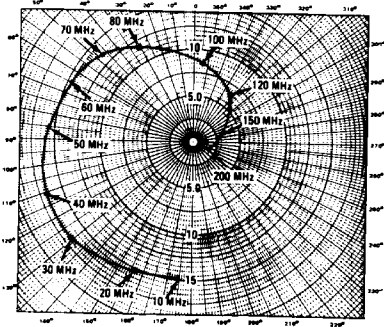
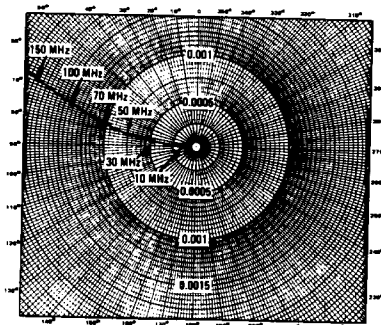

FIGURE 23 – S_{12} , REVERSE TRANSMISSION COEFFICIENT (FEEDBACK)



MC1590G

TYPICAL APPLICATIONS

FIGURE 24 — 60 MHz POWER GAIN TEST CIRCUIT

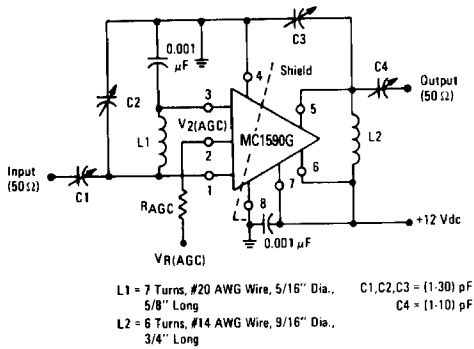
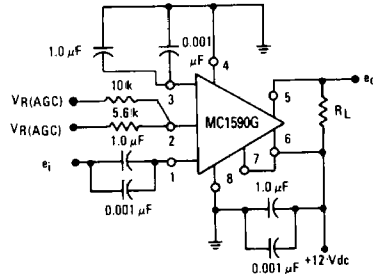

FIGURE 25 — PROCEDURE FOR SETUP USING FIGURE 24

Test	e_{in}	$V_2(AGC)$	$R_{AGC}(k\Omega)$
MAGC	2.23 mV (-40dBm)	5.7 V	0
Gp	1.0 mV (-47dBm)	≤ 5.0 V	5.6
NF	1.0 mV (-47dBm)	≤ 5.0 V	5.6

FIGURE 26 — VIDEO AMPLIFIER



**FIGURE 27 — 30 MHz AMPLIFIER
(Power Gain = 50 dB, BW = 1.0 MHz)**

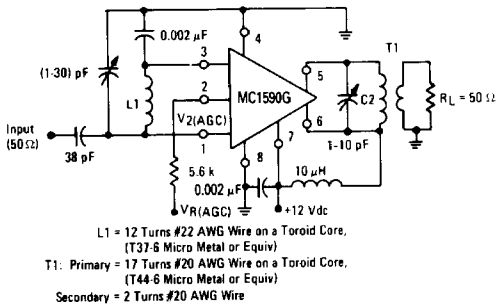

FIGURE 28 — 100 MHz MIXER

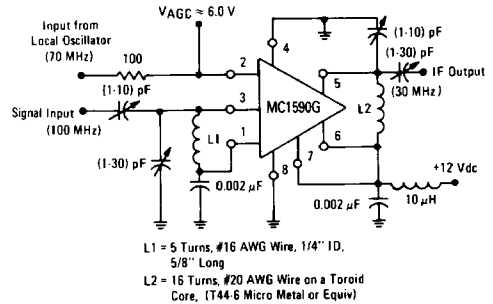
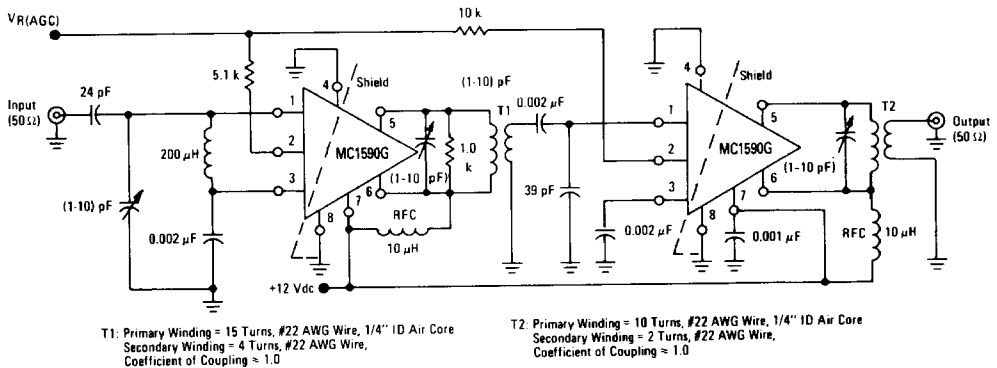
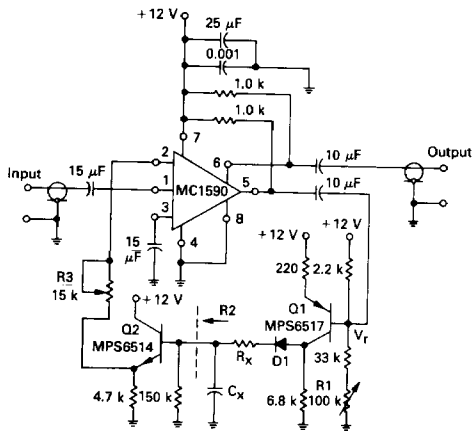

FIGURE 29 — TWO-STAGE 60 MHz IF AMPLIFIER (Power Gain ≈ 80 dB, BW ≈ 1.5 MHz)



TYPICAL APPLICATIONS (continued)

FIGURE 30 – SPEECH COMPRESSOR



DESCRIPTION OF SPEECH COMPRESSOR

The amplifier drives the base of a PNP MPS6517 operating common-emitter with a voltage gain of approximately 20. The control R1 varies the quiescent Q point of this transistor so that varying amounts of signal exceed the level V_r . Diode D1 rectifies the positive peaks of Q1's output only when these peaks are greater than $V_r \approx 7.0$ Volts. The resulting output is filtered by C_x , R_x .

R_x controls the charging time constant or attack time. C_x is involved in both charge and discharge. R2 (the 150 kΩ and input resistance of the emitter-follower Q2) controls the decay time. Making the decay long and attack short is accomplished by making R_x small and R2 large. (A Darlington emitter-follower may be needed if extremely slow decay times are required.)

The emitter-follower Q2 drives the AGC Pin 2 of the MC1590G and reduces the gain. R3 controls the slope of signal compression. The following graph (Figure 31) details performance with R3 set to 15 kΩ.

FIGURE 31 – OUTPUT VOLTAGE versus INPUT VOLTAGE

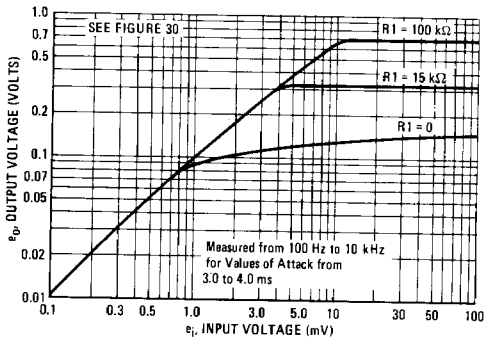

TABLE 1 — DISTORTION versus FREQUENCY

FREQUENCY	DISTORTION		DISTORTION	
	10 mV e_i	100 mV e_i	10 mV e_i	100 mV e_i
100 Hz	3.5%	12%	15%	27%
300 Hz	2%	10%	6%	20%
1.0 kHz	1.5%	8%	3%	9%
10 kHz	1.5%	8%	1%	3%
100 kHz	1.5%	8%	1%	3%

- Notes 1 and 2
- Notes 3 and 4
- Note: (1) Decay = 300 ms
Attack = 20 ms
- (2) $C_x = 7.5 \mu F$
 $R_x = 0$ (Short)
- (3) Decay = 20 ms
Attack = 3 ms
- (4) $C_x = 0.68 \mu F$
 $R_x = 1.5 k\Omega$

FIGURE 32 – OUTPUT CURRENT, CURRENT MATCH AND I_{CC} FIXTURE

