

HVM15

Variable Capacitance Diode for BS/CS tuner

HITACHI

Preliminary
Rev. 2
May. 1993

Features

- Low capacitance, high S/N.
- MPAK package is suitable for high density surface mounting and high speed assembly.

Ordering Information

Type No.	Laser Mark	Package Code
HVM15	T 2	MPAK

Pin Arrangement

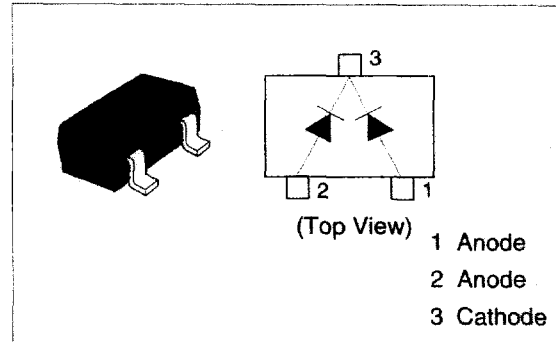

Absolute Maximum Ratings (Ta = 25°C)

Item	Symbol	Value	Unit
Reverse voltage	V_R	35	V
Junction temperature	T_j	125	°C
Storage temperature	T_{stg}	-55 to +125	°C

Electrical Characteristics (Ta = 25°C)

Item	Symbol	Min	Typ	Max	Unit	Test Condition
Reverse voltage	V_R	35	—	—	V	$I_R = 10 \mu A$
Reverse current	I_R	—	—	50	nA	$V_R = 30 V$
Capacitance	C_1	3.6	—	5.6	pF	$V_R = 1 V, f = 1 MHz$
	C_{30}	0.5	—	0.9		$V_R = 30 V, f = 1 MHz$
Capacitance ratio	n	4.0	—	—	—	C_1/C_{30}
Series resistance	r_s	—	—	1.5	Ω	$V_R = 2 V, f = 100 MHz$

HVM15

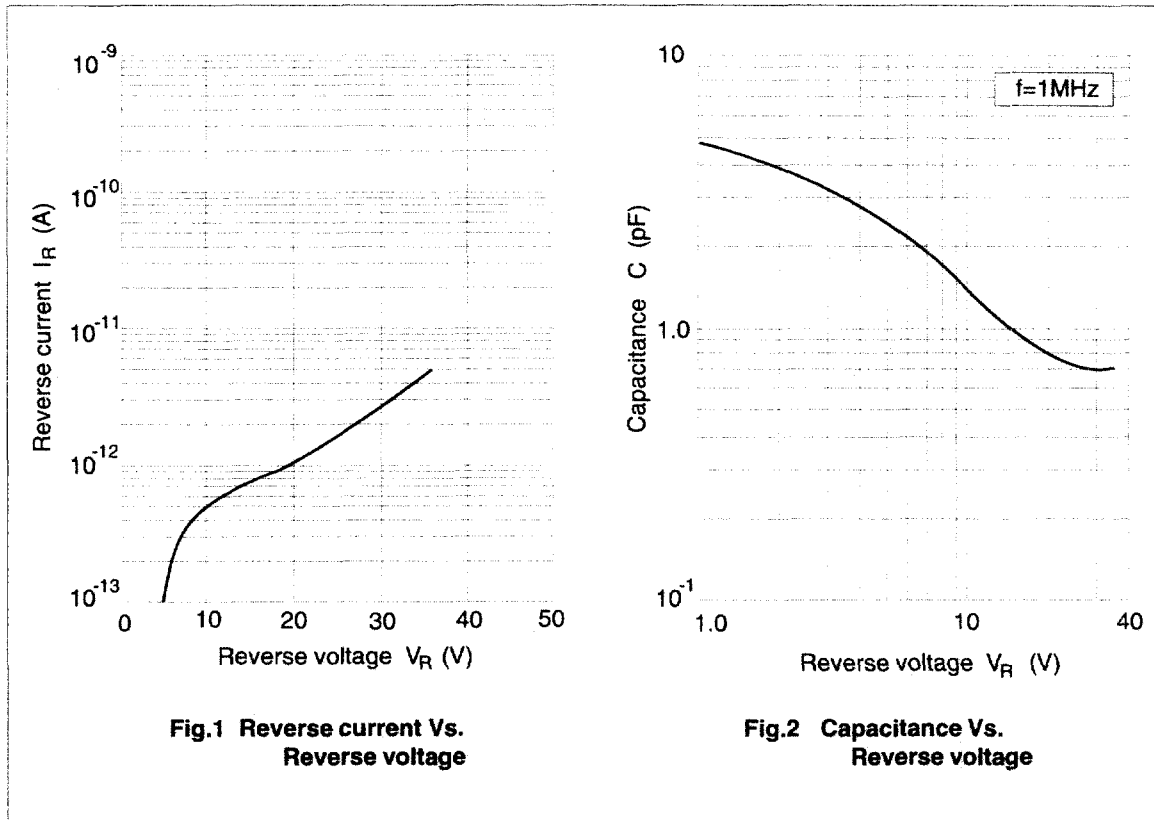

Package Dimensions

Unit: mm

