

PC733H

High Input Current, AC Input Type Photocoupler

* Lead forming type (I type) and taping reel type (P type) are also available. (PC733HI/PC733HP)

■ Features

1. AC input response
2. High input current (I_F : MAX. 150mA)
3. High isolation voltage between input and output
(V_{iso} : 5 000 V_{rms})
4. Low collector dark current
(I_{CEO} : MAX. 10^{-7} A at $V_{CE} = 20V$)
5. TTL compatible output
6. Recognized by UL, file No. E64380

■ Applications

1. Telephone sets
2. System appliances, measuring instruments
3. Signal transmission between circuits of different potentials and impedances

■ Outline Dimensions

(Unit : mm)

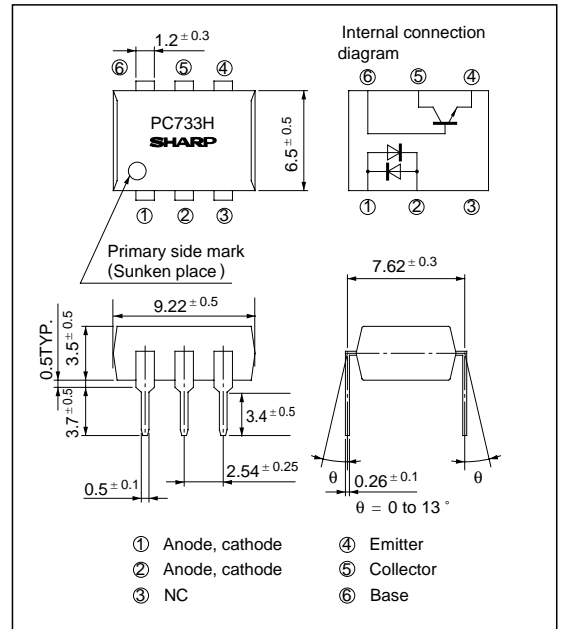

■ Absolute Maximum Ratings

($T_a = 25^\circ\text{C}$)

Parameter		Symbol	Rating	Unit
Input	Forward current	I_F	± 150	mA
	*1 Peak forward current	I_{FM}	± 1	A
	Power dissipation	P	230	mW
Output	Collector-emitter voltage	V_{CEO}	35	V
	Emitter-collector voltage	V_{ECO}	6	V
	Collector-base voltage	V_{CBO}	35	V
	Emitter-base voltage	V_{EBO}	6	V
	Collector current	I_C	80	mA
	Collector power dissipation	P_C	160	mW
	Total power dissipation	P_{tot}	320	mW
*2 Isolation voltage	V_{iso}	5 000	V_{rms}	
Operating temperature		T_{opr}	- 25 to + 100	$^\circ\text{C}$
Storage temperature		T_{stg}	- 55 to + 125	$^\circ\text{C}$
*3 Soldering temperature		T_{sol}	260	$^\circ\text{C}$

*1 Pulse width $\leq 100\mu\text{s}$, Duty ratio : 0.001

*2 40 to 60% RH, AC for 1 minute

*3 For 10 seconds

■ Electro-optical Characteristics

($T_a = 25^\circ\text{C}$)

Parameter		Symbol	Conditions	MIN.	TYP.	MAX.	Unit	
Input	Forward voltage	V_F	$I_F = \pm 100\text{mA}$	-	1.4	1.7	V	
	Peak forward voltage	V_{FM}	$I_{FM} = \pm 0.5\text{A}$	-	-	3.0	V	
	Terminal capacitance	C_t	$V = 0, f = 1\text{kHz}$	-	50	400	pF	
Output	Collector dark current	I_{CEO}	$V_{CE} = 20\text{V}, I_F = 0, R_{BE} = \infty$	-	-	10^{-7}	A	
	Current transfer ratio	CTR	$I_F = \pm 100\text{mA}, V_{CE} = 2\text{V}, R_{BE} = \infty$	20	-	80	%	
Transfer characteristics	Collector-emitter saturation voltage	$V_{CE(sat)}$	$I_F = \pm 100\text{mA}, I_C = 1\text{mA}, R_{BE} = \infty$	-	0.1	0.2	V	
	Isolation resistance	R_{ISO}	DC500V, 40 to 60% RH	5×10^{10}	10^{11}	-	Ω	
	Floating capacitance	C_f	$V = 0, f = 1\text{MHz}$	-	0.6	1.0	pF	
	Cut-off frequency	f_c	$V_{CE} = 5\text{V}, I_C = 2\text{mA}, R_L = 100\Omega, R_{BE} = \infty, -3\text{dB}$	-	15	80	-	kHz
				-	-	3	18	μs
	Response time	Rise time	t_r	$V_{CE} = 2\text{V}, I_C = 2\text{mA},$	-	4	18	μs
	Fall time	t_f	$R_L = 100\Omega, R_{BE} = \infty$	-	3	18	μs	

Fig. 1 Forward Current vs. Ambient Temperature

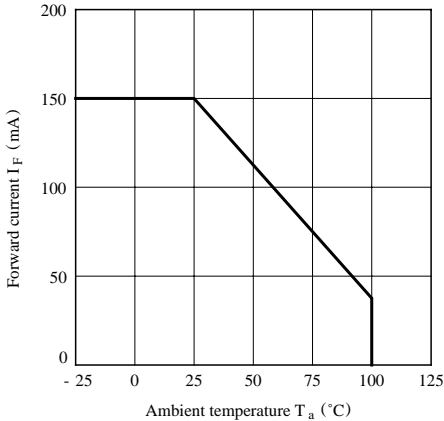

Fig. 2 Collector Power Dissipation vs. Ambient Temperature

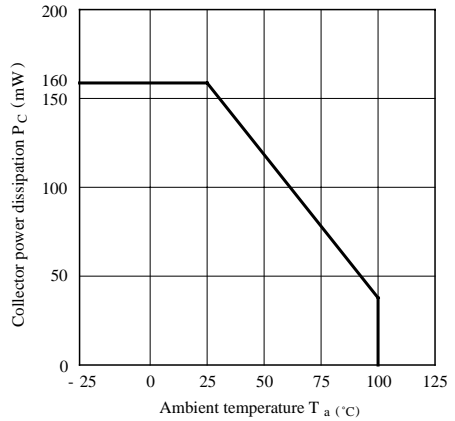

Fig. 3 Peak Forward Current vs. Duty Ratio

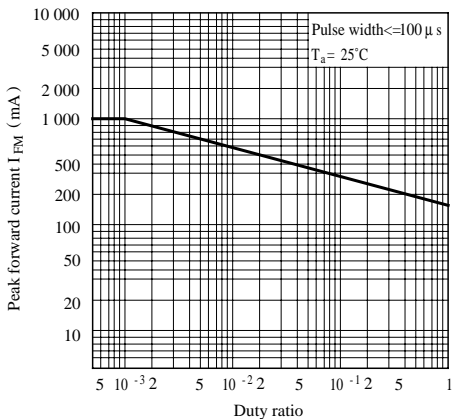

Fig. 4 Forward Current vs. Forward Voltage

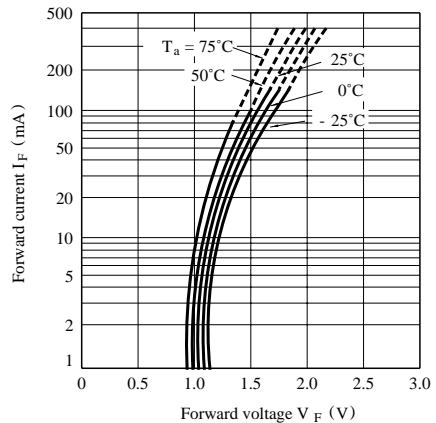

Fig. 5 Current Transfer Ratio vs. Forward Current

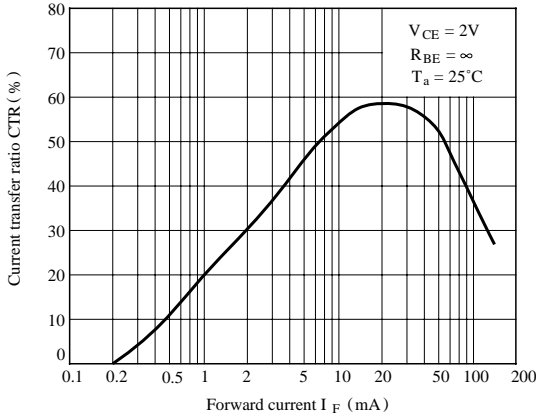

Fig. 6 Collector Current vs. Collector-emitter Voltage

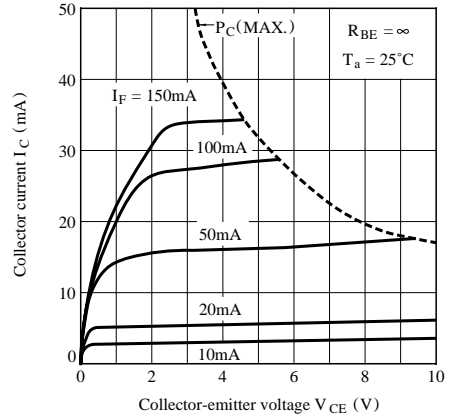

Fig. 7 Relative Current Transfer Ratio vs. Ambient Temperature

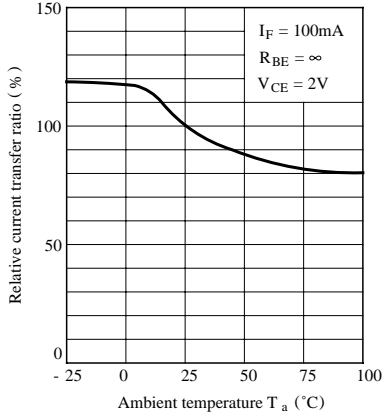

Fig. 8 Collector-emitter Saturation Voltage vs. Ambient Temperature

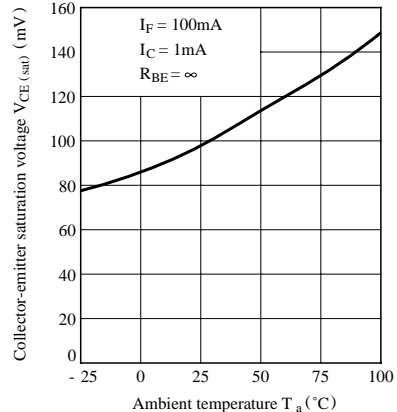

Fig. 9-a Collector Dark Current vs. Ambient Temperature

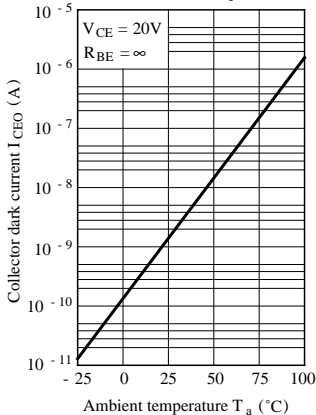

Fig. 9-b Collector-base Dark Current vs. Ambient Temperature

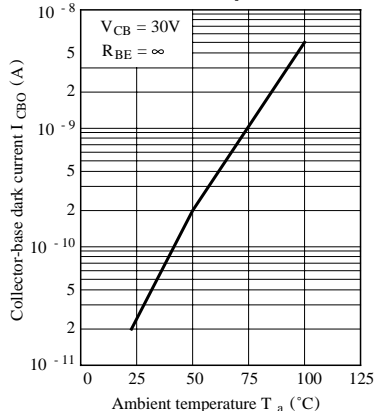
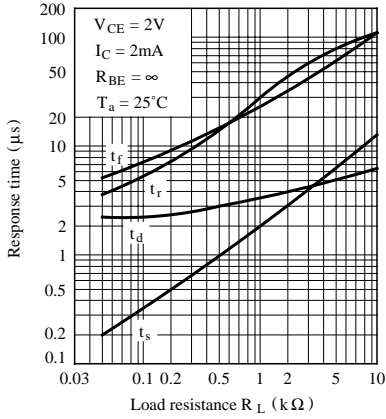
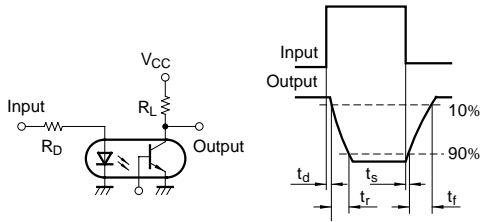

Fig.10 Response Time vs. Load Resistance



Test Circuit for Response Time



Test Circuit for Frequency Response

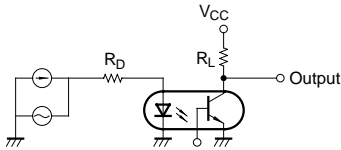

Fig.11 Frequency Response

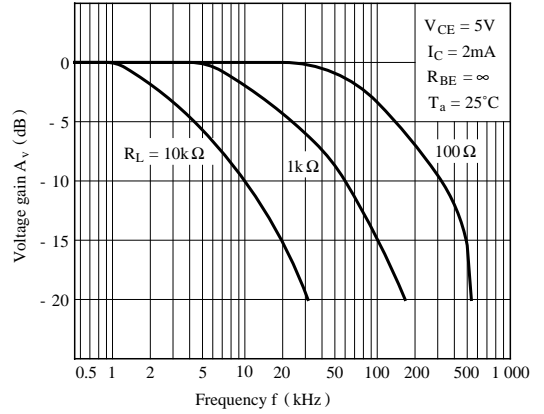
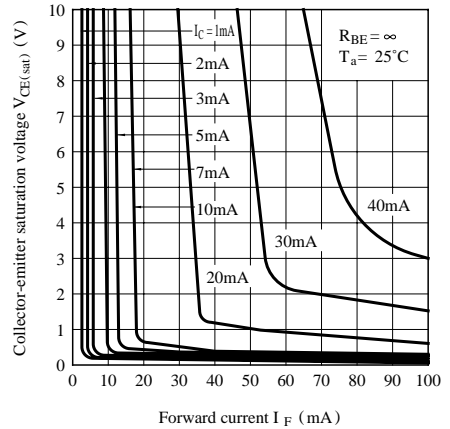

Fig.12 Collector-emitter Saturation Voltage vs. Forward Current



● Please refer to the chapter “Precautions for Use”.