

TC4518BP/TC4518BF DUAL BCD UP COUNTER
TC4520BP/TC4520BF DUAL BINARY UP COUNTER

TC4518BP/BF and TC4520BP/BF are up counters of BCD or 4 bit binary.

Since both of TC4518BP/BF and TC4520BP/BF contain two independent circuits of counters with the same functions in one package, counting or frequency division of two BCD digits or eight binary bits can be achieved with one IC. The counters can be reset to "0" (Q0~Q3="L") by giving "H" level signal to RESET input regardless of other inputs.

The counting condition is changed by the rising edge of CLOCK input if ENABLE="H" or by the falling edge of ENABLE if CLOCK="L".

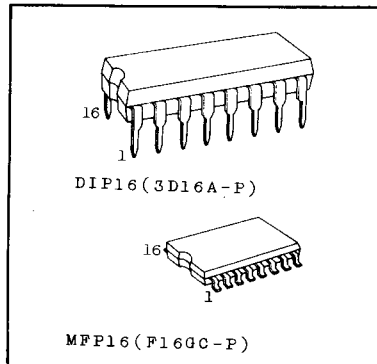

ABSOLUTE MAXIMUM RATINGS

CHARACTERISTIC	SYMBOL	RATING	UNIT
DC Supply Voltage	V _{DD}	V _{SS} -0.5 ~ V _{SS} +20	V
Input Voltage	V _{IN}	V _{SS} -0.5 ~ V _{DD} +0.5	V
Output Voltage	V _{OUT}	V _{SS} -0.5 ~ V _{DD} +0.5	V
DC Input Current	I _{IN}	±10	mA
Power Dissipation	P _D	300(DIP)/180(MFP)	mW
Operating Temperature Range	T _A	-40 ~ 85	°C
Storage Temperature Range	T _{stg}	-65 ~ 150	°C
Lead Temp./Time	T _{sol}	260°C • 10sec	

PIN ASSIGNMENT

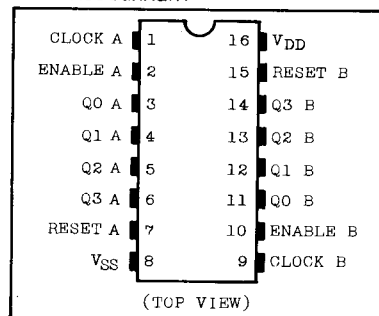

LOGIC DIAGRAM

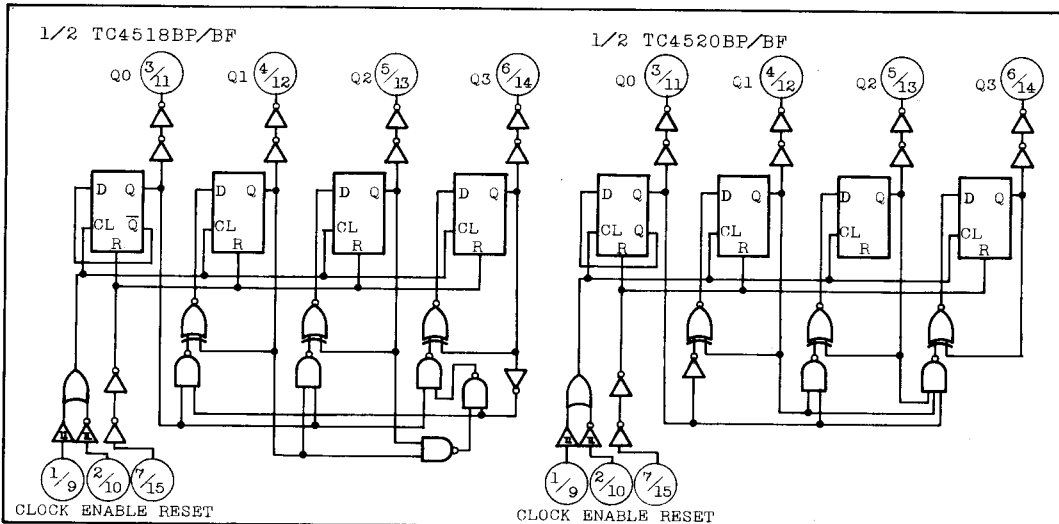

TC4518BP/BF, TC4520BP/BF

TIMING CHART

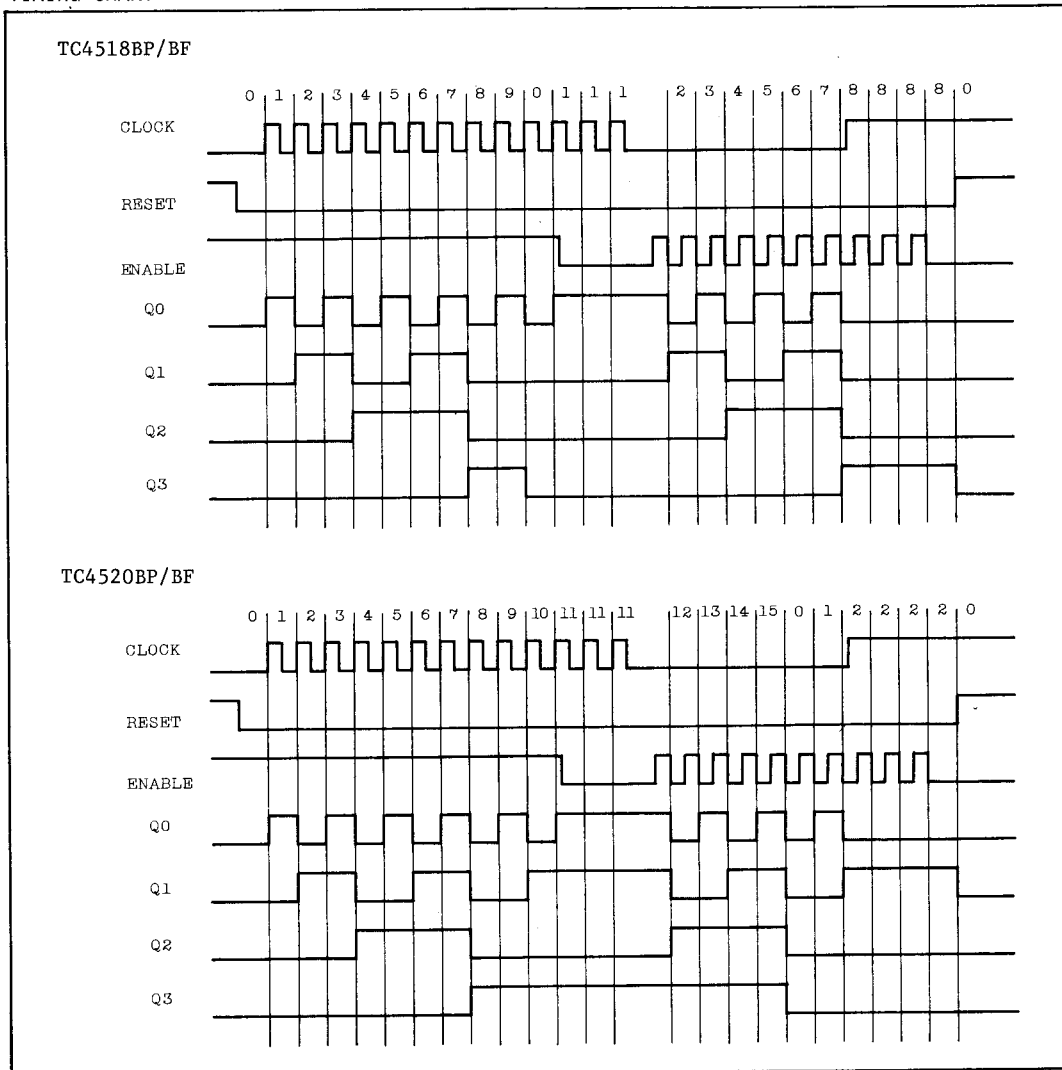

RECOMMENDED OPERATING CONDITIONS (V_{SS}=0V)

CHARACTERISTIC	SYMBOL	MIN.	TYP.	MAX.	UNIT
DC Supply Voltage	V _{DD}	3	-	18	V
Input Voltage	V _{IN}	0	-	V _{DD}	

STATIC ELECTRICAL CHARACTERISTICS (V_{SS}=0V)

CHARACTERISTIC	SYMBOL	TEST CONDITION	V _{DD} (V)	-40°C		25°C			85°C		UNIT	
				MIN.	MAX.	MIN.	TYP.	MAX.	MIN.	MAX.		
High-Level Output Voltage	V _{OH}	I _{OUT} < 1μA V _{IN} =V _{SS} , V _{DD}	5	4.95	-	4.95	5.00	-	4.95	-	V	
			10	9.95	-	9.95	10.00	-	9.95	-		
			15	14.95	-	14.95	15.00	-	14.95	-		
Low-Level Output Voltage	V _{OL}	I _{OUT} < 1μA V _{IN} =V _{SS} , V _{DD}	5	-	0.05	-	0.00	0.05	-	0.05		
			10	-	0.05	-	0.00	0.05	-	0.05		
			15	-	0.05	-	0.00	0.05	-	0.05		
Output High Current	I _{OH}	V _{OH} =4.6V	5	-0.61	-	-0.51	-1.0	-	-0.42	-	mA	
		V _{OH} =2.5V	5	-2.5	-	-2.1	-4.0	-	-1.7	-		
		V _{OH} =9.5V	10	-1.5	-	-1.3	-2.2	-	-1.1	-		
		V _{OH} =13.5V	15	-4.0	-	-3.4	-9.0	-	-2.8	-		
		V _{IN} =V _{SS} , V _{DD}										
Output Low Current	I _{OL}	V _{OL} =0.4V	5	0.61	-	0.51	1.2	-	0.42	-		
		V _{OL} =0.5V	10	1.5	-	1.3	3.2	-	1.1	-		
		V _{OL} =1.5V	15	4.0	-	3.4	12.0	-	2.8	-		
		V _{IN} =V _{SS} , V _{DD}										
Input High Voltage	V _{IH}	V _{OUT} =0.5V, 4.5V	5	3.5	-	3.5	2.75	-	3.5	-		V
		V _{OUT} =1.0V, 9.0V	10	7.0	-	7.0	5.5	-	7.0	-		
		V _{OUT} =1.5V, 13.5V	15	11.0	-	11.0	8.25	-	11.0	-		
		I _{OUT} < 1μA										
Input Low Voltage	V _{IL}	V _{OUT} =0.5V, 4.5V	5	-	1.5	-	2.25	1.5	-	1.5		
		V _{OUT} =1.0V, 9.0V	10	-	3.0	-	4.0	3.0	-	3.0		
		V _{OUT} =1.5V, 13.5V	15	-	4.0	-	6.75	4.0	-	4.0		
		I _{OUT} < 1μA										
Input Current	"H" Level	I _{IH}	V _{IH} =18V	18	-	0.1	-	10 ⁻⁵	0.1	-	1.0	μA
	"L" Level	I _{IL}	V _{IL} =0V	18	-	-0.1	-	-10 ⁻⁵	-0.1	-	-1.0	
Quiescent Device Current	I _{DD}	V _{IN} =V _{SS} , V _{DD} *	5	-	5	-	0.005	5	-	150		
			10	-	10	-	0.010	10	-	300		
			15	-	20	-	0.015	20	-	600		

* All valid input combinations.

TC4518BP/BF, TC4520BP/BF

DYNAMIC ELECTRICAL CHARACTERISTICS (Ta=25°C, VSS=0V, CL=50pF)

CHARACTERISTIC	SYMBOL	TEST CONDITION	V _{DD} (V)	MIN.	TYP.	MAX.	UNIT
Output Transition Time	t _{TLH} t _{THL}		5	-	70	200	ns
			10	-	35	100	
			15	-	30	80	
Propagation Delay Time (CLOCK, ENABLE - Q)	t _{pLH} t _{pHL}		5	-	160	560	
			10	-	75	230	
			15	-	60	160	
Propagation Delay Time (RESET - Q)	t _{pHL}		5	-	110	560	
			10	-	55	230	
			15	-	40	160	
Max. Clock Frequency	f _{CL}		5	1.5	6	-	MHz
			10	3	14	-	
			15	4	18	-	
Max. Clock Input Rise/ Fall Time	t _{rCL} t _{fCL}		5	No Limit			μs
			10	No Limit			
			15	No Limit			
Max. Input Rise/Fall Time (ENABLE)	t _r t _f		5	No Limit			
			10	No Limit			
			15	No Limit			
Min. Clock Pulse Width	t _w		5	-	30	200	ns
			10	-	15	100	
			15	-	10	70	
Min. Pulse Width (ENABLE)	t _w		5	-	35	250	
			10	-	20	110	
			15	-	15	80	
Min. Pulse Width (RESET)	t _{wH}		5	-	45	250	
			10	-	20	110	
			15	-	15	80	
Min. Removal Time	t _{rem}		5	-	-	0	
			10	-	-	0	
			15	-	-	0	
Input Capacitance	C _{IN}			-	5	7.5	pF

WAVEFORMS FOR MEASUREMENT OF DYNAMIC CHARACTERISTICS

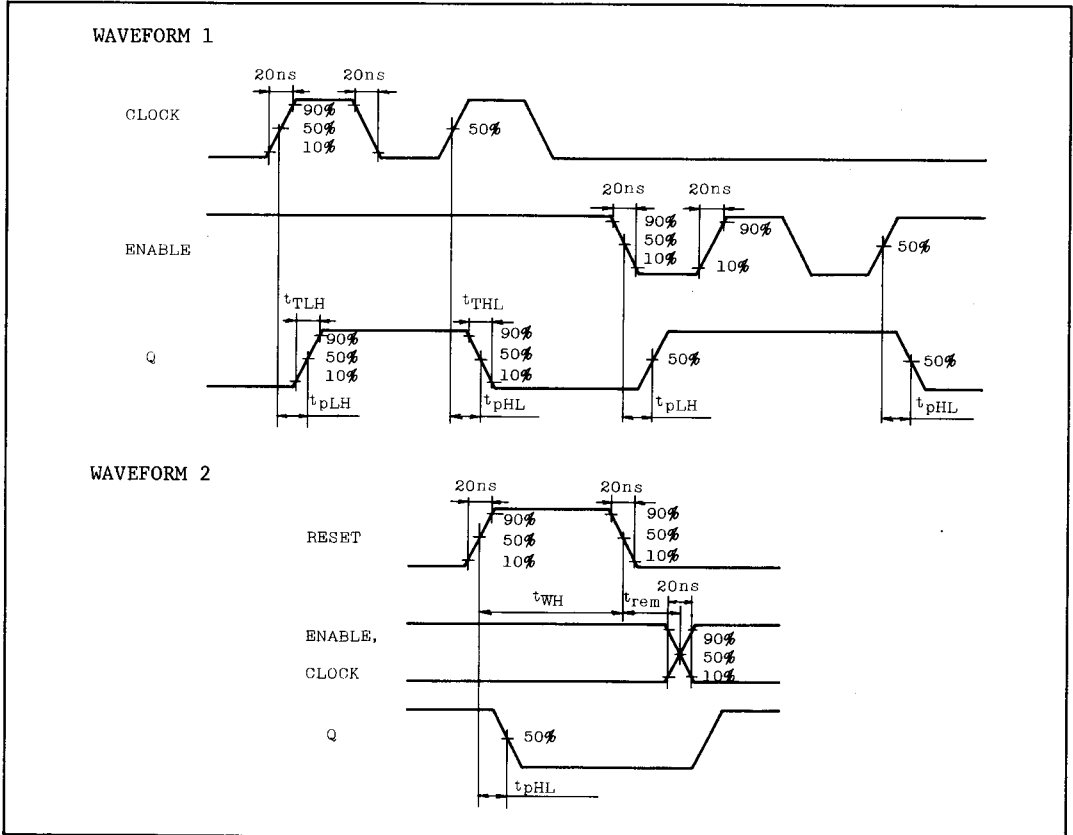

APPLICATION CIRCUIT

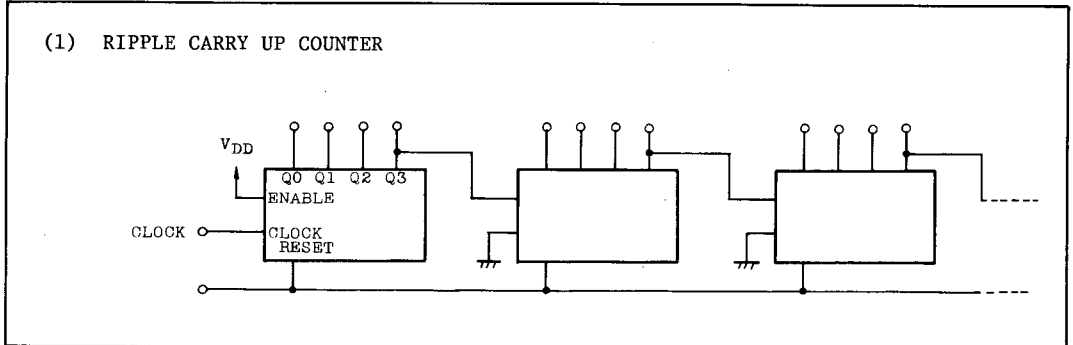

TC4518BP/BF, TC4520BP/BF

APPLICATION CIRCUIT (Continued)

(2) PARALLEL CARRY UP COUNTER

TC4518BP/BF

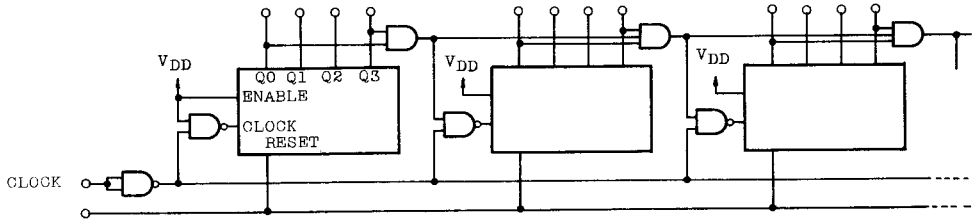

TC4520BP/BF

